



PRISONS STATISTICS OF SRI LANKA



STATISTICS DIVISION
PRISON HEADQUARTERS
COLOMBO - 09,
SRI LANKA.
www.prisons.gov.lk
prisons@sltnet.lk

VOL. 33 - YEAR 2014

I S B N 978 - 955 - 9342 - 29 - 8

PREFACE

The publication of the "Prison Statistics of Sri Lanka" is in itself a remarkable feat, displaying an immense effort on the part of Prison officers, and officers of the Statistical Department of the Prison. That This publication is in its 33rd year is further testimony to the tireless effort gone into the making of this Journal.

The degree of statistical information available in this publication makes it an invaluable aid to social scientists, administrators, legislators, and researchers investigating criminal tendencies and the workings of the prison system.

I wish to show my sincere appreciation to all those who made this publication possible and wish them all success in their future endeavors.

Chandrarathna Pallegama
Commissioner General of Prisons

11th December 2014
Department of Prisons,
Prison Headquarters,
Colombo 09,
Sri Lanka.

COMPLETION OF CENTURY

COMPLETION OF CENTURY
COMPLETION OF CENTURY











FOREWORD

This bulletin of Prison Statistics of Sri Lanka is the 33rd issue in this series and its objective is to provide basic information on Convicted and Unconvicted prisoners in Sri Lanka. The Publication is divided into ten sections and has around 90 very useful tabulations, which I am confident will be useful to those who are interested in studying the ways and means of reducing the crime rate in Sri Lanka, social scientists, administrators, members of Judiciary, legislators, researchers and other data users.

I wish to thank Mr. Chandrarathna Pallegama Commissioner General of Prisons for valuable assistance given and to Mr. R.I.B.C.Rathnamalala and K.K.Hemasiri Prison Officer of the Statistics Branch of the Prison Headquarters, for kind and valuable assistance extended to Mr. H.W.Athula Kumara, Statistical Officer to make this Publication a success.

D.C.A. Gunawardena
Director General of Census and Statistics

15th October 2014
Department of Census and Statistics,
5th floor, Rotunda Tower,
No: 109, Galle Road,
Colombo 03,
Sri Lanka.

<p><u>Unconvicted Male Prisoner</u></p>  <p>Ordinary dress</p>	<p><u>Convicted Male Prisoner</u></p>  <p>White Jumper & white slack</p>	<p><u>Condemned Male Prisoner</u></p>  <p>Long sleeved white Jumper & check cloth</p>
<p><u>Unconvicted Female Prisoner</u></p>  <p>Ordinary dress</p>	<p><u>Convicted Female Prisoner</u></p>  <p>White blouse & white cloth</p>	<p><u>Condemned Female Prisoner</u></p>  <p>White blouse & check cloth</p>
<p><u>Appellant Male Prisoner</u></p>  <p>White Jumper marked "PA" and white slack</p>	<p><u>Appellant Female Prisoner</u></p>  <p>White blouse marked "PA" and white cloth</p>	<p><u>Youthful Offender</u></p>  <p>Khaki twill shirt (Short sleeved) & Khaki drill pair of Shorts.</p>

TERMINOLOGY

1. Closed Prisons – Institution with a perimeter wall where prisoners are held normally under maximum security conditions.
2. Remand Prisons – Closed Prisons exclusively kept apart for remand prisoners.
3. Open Prison Camps – Prisons without a perimeter wall where selected prisoners are held under minimum security conditions.
4. Work Camps – Prisons without a perimeter wall where short term or medium term offenders are detained under minimum security conditions.
5. Work Release Center – Prison buildings without a perimeter wall or security devices which provide lodging for the night to prisoners who are sent out on work release under the work release scheme.
6. Lock-up – Prison buildings sited near courts to which prisoners with pending cases are transferred a day or two before the date of trial of the cases for the purpose of their production before court and removal back immediately afterwards. Similarly persons sentenced to prison by courts are temporarily kept in these buildings till their transfer to closed prison.
7. Convicted Prisoners – Prisoners who have been convicted of offences under the law by various courts in the Island and sentenced to a term of imprisonment.
8. Remand Prisoners – Unconvicted prisoners awaiting trial.
9. First Offender – A person who has been admitted to prison for the first time.
10. Reconvicted Offender – A person who has been admitted to prison a second time.
11. Recidivist – A person who has been admitted to prison on more than two occasions.
12. Youthful Offenders – Offenders who are between the ages of 16 and 22 years.
13. Home Leave Scheme – A scheme under which certain categories of prisoners are permitted to visit their homes unescorted for a maximum period of 7 days at a time, once in 6 months.
14. License Scheme – A scheme under which certain categories of prisoners are conditionally released from prison prematurely under the supervision of prison welfare officers.
15. Work Release Scheme – A scheme under which selected prisoners are allowed to get themselves employed in the open community unescorted during day and return to a work release centre or a prison for the night.

CONTENTS

	Page
PREFACE	iii
FOREWARD	v
TERMINOLOGY	vii
SECTION TABLE	
1 .Prison Institutions of Sri Lanka	1
1.1 Prison institutions of Sri Lanka	3
2 .Departmental Staff	7
2.1 Departmental Staff Classified According to Grades 2010 - 2013	9
2.2 Departmental Staff Trained at the Center for Research and Training in Corrections 2009 - 2013	11
3. Unconvicted Prisoners	13
3.1 Direct Admissions of Unconvicted Prisoners by Institutions 2009 - 2013	14
3.2 Direct Admissions of Unconvicted Prisoners According to Age 2009 - 2013	15
3.3 Direct Admissions of Unconvicted Prisoners According to Literacy 2009 - 2013	15
3.4 Direct Admissions of Unconvicted Prisoners by Race and the Percentage Distribution 2009 - 2013	17
3.5 Direct Admissions of Unconvicted Prisoners by Religion and the Percentage Distribution 2009 - 2013	17
3.6 Direct Admissions of Unconvicted Prisoners According to Marital Status 2009 - 2013	19
3.7 Statistics Relating to the Custody of Remand Prisoners 2010 - 2013	20
3.8 Period Spent on Remand by Prisoners Awaiting Trial 2013	21
3.9 Direct Admissions of Unconvicted Prisoners by Districts 2011 - 2013	22
3.10 Length of Period spent in Custody of all Remandees as on 31 st of December, 2013	23
3.11 Average Length of Time spent on Remand as on as on 31 st of December of each year 2009 - 2013	23
3.12 Daily Average of Unconvicted Prisoners 2003 - 2013	23
3.13 Annual Admissions of Convicted and Remand Prisoners 2005 - 2013	24
3.14 Daily Average of Convicted and Unconvicted Prisoners 2005 - 2013	24
4. Convicted Prisoners	25
4.1 Direct Admissions of Convicted Prisoners by Institutions 2009 - 2013	26
4.2 Direct Admissions of Convicted Prisoners According to Age 2009 - 2013	27
4.3 Direct Admissions of Convicted Prisoners According to Literacy 2009 - 2013	27
4.4 Direct Admissions of Convicted Prisoners by Race and the Percentage Distribution 2009-2013	29
4.5 Direct Admissions of Convicted Prisoners by Religion and the Percentage Distribution 2009 - 2013	29
4.6 Direct Admissions of Convicted Prisoners According to Marital Status 2009 - 2013	31
4.7 Direct Admissions of Convicted Prisoners by Districts 2011 - 2013	32
4.8 Number of Convicted Prisoners according to Previous Convictions 2010 - 2013	33
4.9 Direct Admissions to Prisons and Training Schools (Rate of Admissions of Convicted and Unconvicted Prisoners) 2007 - 2013	33
4.10 Direct Admissions of Convicted Prisoners by Institutions during the years 2011 - 2012, 2012 - 2013 and the Numerical and Percentage Increase / Decrease	34
4.11 Direct Admissions of Convicted Prisoners by Catagories of Offences 2009 - 2013	34
4.12 Direct Admissions of Convicted Prisoners by Type of Offences and Rate per 100,000 of Population 2007 - 2013	35
4.13 Direct Admissions of Convicted Prisoners According to Narcotic Drugs and Excise Offences 2009 - 2013	38

Section Table (Contd.)

4.14	Direct Admissions of Convicted Prisoners According to Selected Offences 2009 - 2013	38
4.15	Grave Crime Offences Against Persons 2007 - 2013	39
4.16	Grave Crime Offences Against Property 2007 - 2013	39
4.17	Direct Admissions of Training School Inmates Prisoners Sentenced to Death and Other Convicted prisoners According to Age 2011 - 2013	40
4.18	Direct Admissions of Convicted Prisoners According to Courts 2009 - 2013	40
4.19	Direct Admissions of Convicted and Unconvicted Foreign Prisoners by Country, Sex and Type of Offences 2012 - 2013	41
4.20	Direct Admissions of Woman Prisoners (Convicted and Unconvicted) by Institutions 2007 - 2013	42
4.21	Direct Admissions of Woman Prisoners (Convicted and Unconvicted) According to Age 2007 - 2013	42
4.22	Direct Admissions of Convicted Woman Prisoners According to Selected Offences 2007 - 2013	43
4.23	The First Offenders and Recidivists 2003 - 2013	43
4.24	Daily Average Strength of Convicted and Unconvicted Prisoners by Institutions 2009 - 2013	44
4.25	Length of Sentences 2009 - 2013	45
4.26	Discharge of Convicted Prisoners 2011 - 2013	45
5. Direct Admissions to the Training School for Youthful Offenders - Wathupitiwala		
Functions at Ambepussa since 2009		47
5.1	Direct Admissions and Daily Average Population at the Training School for Youthful Offenders 2004 - 2013	48
5.2	Direct Admissions to Training School for Youthful Offenders According to Age 2009 - 2013	48
5.3	Direct Admissions to Training School for Youthful Offenders According to Residence 2009 - 2013	48
5.4	Direct Admissions to Training School for Youthful Offenders According to Marital Status of Delinquent's family 2009 - 2013	49
5.5	Direct Admissions to Training School for Youthful Offenders According to Up-Bringing 2009 - 2013	49
5.6	Direct Admissions to Training School for Youthful Offenders According to Family Particulars 2009 - 2013	49
5.7	Direct Admissions to Training School for Youthful Offenders According to Position of Delinquent 2009 - 2013	50
5.8	Direct Admissions to Training School for Youthful Offenders According to Mental Disposition 2009 - 2013	50
5.9	Direct Admissions to Training School for Youthful Offenders According to Literacy 2009 - 2013	50
6. Death Sentences		51
6.1	Death Sentences 2003 - 2013	52
6.2	Direct Admissions of Prisoners Sentenced to Death According to Sex 2009 - 2013	52
6.3	Direct Admissions of Prisoners Sentenced to Death According to Race 2009 - 2013	52
6.4	Direct Admissions of Prisoners Sentenced to Death According to Religion 2009 - 2013	53
6.5	Direct Admissions of Prisoners Sentenced to Death According to Marital Status 2009 - 2013	53
6.6	Direct Admissions of Prisoners Sentenced to Death According to Literacy 2009 - 2013	53
6.7	Direct Admissions of Prisoners Sentenced to Death According to Districts 2009 - 2013	54
6.8	Direct Admissions of Prisoners Sentenced to Death According to Residence 2009 - 2013	54
6.9	Direct Admissions of Prisoners Sentenced to Death According to Previous Punishments 2009 - 2013	55
Section Table (Contd.)		
6.10	Direct Admissions of Prisoners Sentenced to Death According to Previous Convictions 2009 - 2013	55
6.11	Direct Admissions of Prisoners Sentenced to Death According to Income of Offenders 2009 - 2013	55
6.12	Direct Admissions of Prisoners Sentenced to Death According to Personal Habits 2009 - 2013	56
6.13	Direct Admissions of Prisoners Sentenced to Death According to Occupation 2009 - 2013	57

7. Prisoners Released on Work Release Scheme,License Scheme and Home Leave Scheme	59
7.1 Prisoners Released on Work Release, Home Leave and on License Scheme 2003 - 2013	60
7.2 Prisoners engaged on Work Release Scheme 2003 - 2013	60
7.3 Prisoners Released on Lisence Scheme 2003 - 2013	61
7.4 Prisoners sent on Home Leave Scheme 2003 - 2013	61
8.The Value of Industrial and Agricultural output	63
8.1 The Value of Industrial and Agricultural output (from all the Institutions) 2009 - 2013	64
8.2 Comparative Statement of Cost of Supplies 2012 - 2013	65
9. General	67
9.1 Prisoners Escaped,Recaptured and At-Large 2004 - 2013	68
9.2 Imprisonment for Default of Payment of Fines 2004 - 2013	68
9.3 Population Figures of Convicted Prisoners by Institutions as at 31 st of January and 31 st of December of each year under reference 2012 - 2013	69
9.4 Population of Convicted Prisoners by Literacy and Sex 2004 - 2013	70
9.5 The Number of Prisoners Treated in Prisons and Civil Hospitals 2009 - 2013	70
9.6 Number of Deaths and the Death Rate 2004 - 2013	71
9.7 Accomodation and Buildings 2004 - 2013	71
9.8 Recurrent Expenditure,Capital Expenditure, the Average Cost per Prisoners and Cost of Food per Prisoner (Rupees) 2009 - 2013	72
10. Drug Offenders	73
10.1 Direct Admissions of Convicted Prisoners and Narcotic Drug Offences 2001 - 2012	74
10.2 Drug Offenders According to Type of Drugs 2001 - 2012	74
10.3 Drug Offenders According to Districts 2001 - 2012	75
10.4 Drug Offenders According to Race 2001 - 2012	76
10.5 Drug Offenders According to Religion 2001 - 2012	76
10.6 Drug Offenders According to Age Groups 2001 - 2012	78
10.7 Drug Offenders According to Educational Level 2001 - 2012	78
10.8 Drug Offenders According to Marital Status 2001 - 2012	80
10.9 Drug Offenders According to Period of Sentence 2001 - 2012	80
10.10 Drug Offenders According to Parents Alive or Not 2001 - 2012	81
10.11 Drug Offenders According to First Offenders & Recidivist - 2012	81
CHRONOLOGY	82

DIRECT ADMISSIONS OF CONVICTED AND UNCONVICTED PRISONERS BY INSTITUTIONS - 2013

INSTITUTION	UNCONVICTED			CONVICTED		
	MALE	FEMALE	TOTAL	MALE	FEMALE	TOTAL
Welikada Prison	1,762	1,941	3,703	11,369	428	11,797
Colombo Remand Prison	5,463	-	5,463	-	-	-
New Magazine Remand Prison	9,429	-	9,429	-	-	-
Mahara Prison	7,986	-	7,986	3,178	-	3,178
Bogambara Prison	3,638	-	3,638	1,700	-	1,700
Kandy Remand Prison	3,148	572	3,720	-	50	50
Jaffna Remand Prison	2,872	170	3,042	236	17	253
Anuradhapura Remand Prison	5,496	391	5,887	1,390	36	1,426
Badulla Remand Prison	3,473	155	3,628	569	2	571
Batticaloa Remand Prison	3,482	253	3,735	759	46	805
Galle Remand Prison	4,860	214	5,074	1,402	68	1,470
Matara Remand Prison	2,966	163	3,129	371	6	377
Tangalle Remand Prison	3,339	149	3,488	455	4	459
Negambo Remand Prison	8,253	823	9,076	2,022	70	2,092
Ambepussa T.S. Y.O.	-	-	-	29	-	29
Trincomalee Remand Prison	2,115	89	2,204	347	10	357
Kegalle Remand Prison	4,205	-	4,205	991	-	991
Kalutara Remand Prison	5,703	450	6,153	1,692	43	1,735
Kuruwita Remand Prison	4,009	208	4,217	1,120	26	1,146
Polonnaruwa Remand Prison	1,898	107	2,005	397	16	413
Monaragala Remand Prison	2,495	111	2,606	440	9	449
Boossa Prison	-	-	-	-	-	-
Wariyapola Remand Prison	3,421	350	3,771	768	45	813
Vavuniya Remand Prison	3,351	129	3,480	631	18	649
Total	93,364	6,275	99,639	29,866	894	30,760

Source : Department of Prisons

1

PRISON INSTITUTIONS OF SRI LANKA

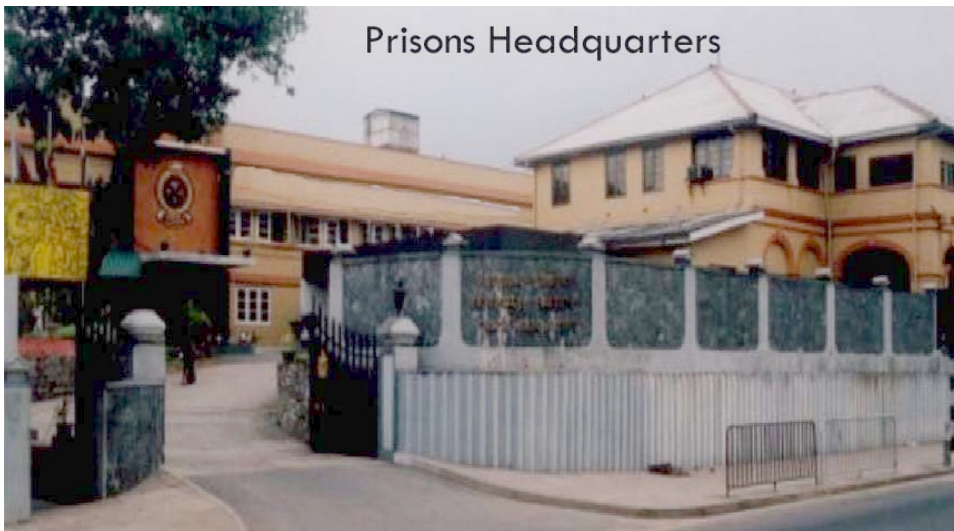

Welikada Prison

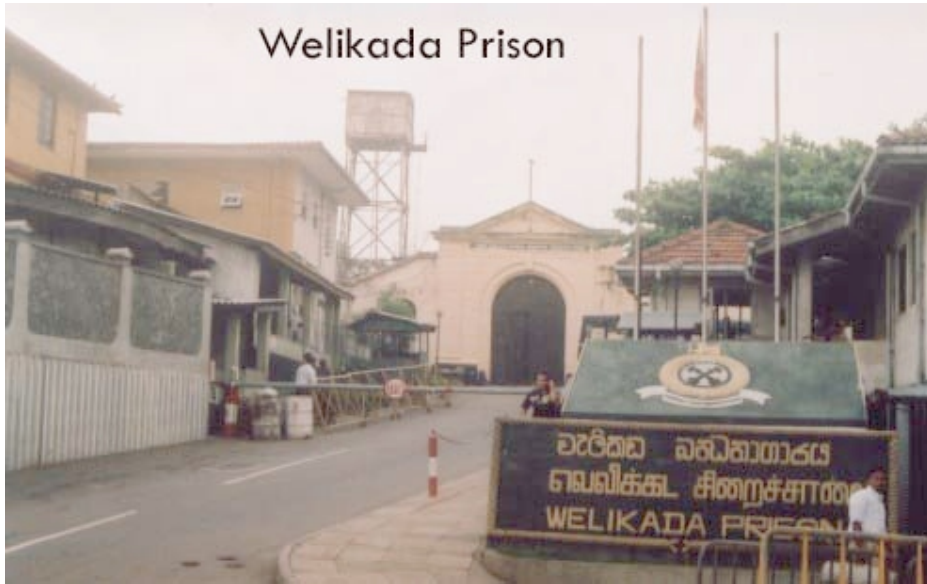

Bogambara Prison



Mahara Prison

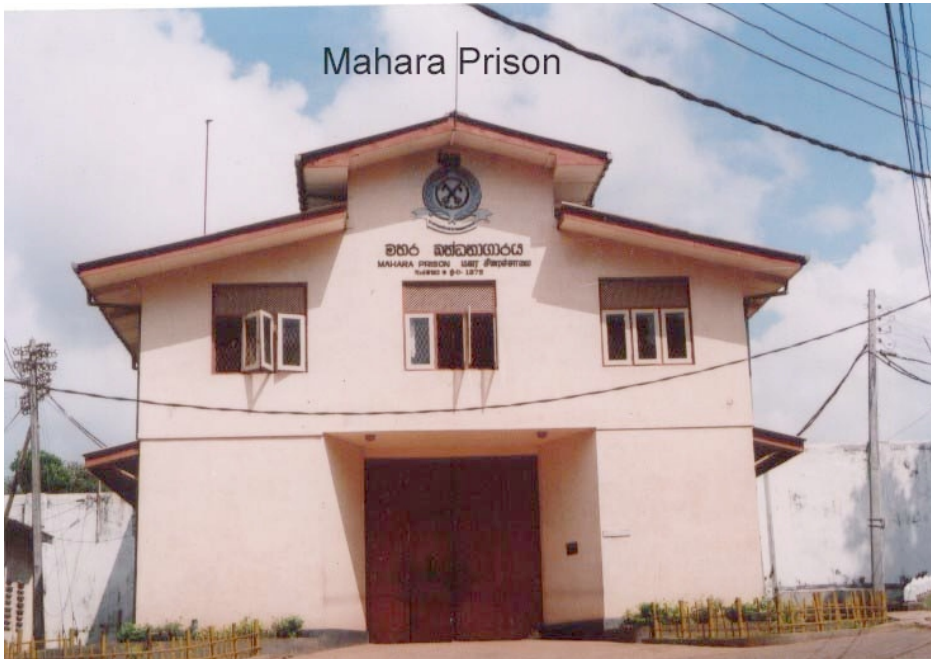

Table 1.1

PRISON INSTITUTIONS OF SRI LANKA

1.1.1 Prison Headquarters, Colombo 09, Sri Lanka.

(Functioning under the Ministry of Rehabilitation and Prison Reforms, Sri Lanka)

1.1.2 Center for Research and Training in Corrections, Colombo 09.

1.2.0 Closed Prisons - (For Convicted Prisoners) - 03

1.2.1 Welikada Prison

1.2.2 Mahara Prison

1.2.3 Bogambara Prison

1.3.0 Remand Prisons - 20

1.3.1 Colombo

1.3.8 Galle

1.3.15 kuruwita

1.3.2 Kandy

1.3.9 Matara

1.3.16 Boossa

1.3.3 Tangalle

1.3.10 Negombo

1.3.17 Monaragala

1.3.4 Jaffna

1.3.11 New Magazine

1.3.18 Polonnaruwa

1.3.5 Anuradhapura

1.3.12 Kegalle

1.3.19 Wariyapola

1.3.6 Batticaloa

1.3.13 Trincomalee

1.3.20 Vavuniya

1.3.7 Badulla

1.3.14 Kalutara

1.4.0 Work Camps - 10

1.4.1 Watareka

1.4.5 Anuradhapura

1.4.9 Thunkama

1.4.2 Meetirigala

1.4.6 Kuruwita

1.4.10 Hangilipola

1.4.3 Navodawa

1.4.7 Wariyapola

1.4.4 Weerawila *

1.4.8 Kandewatta

1.5.0 Open Prison Camps - 02

1.5.1 Pallekelle *

1.5.2 Anuradhapura

1.6.0 Tranning Schools - 01

1.6.1 Tranning Schools for Youthful Offenders, Ambepussa.

1.7.0 Correctional Centres for Youthful Offenders - 02

1.7.1 Pallansena C.C.Y.O. - Closed Prison and Open Camp

1.7.2 Taldena C.C.Y.O. - Open Camp *

* These Institutions are used as Centres for Drug Rehabilitation Operations.

1.8.0 Lock - Ups - 23

<u>Name of Lock - ups</u>	<u>Disrtict</u>	<u>Name of Lock - ups</u>	<u>Disrtict</u>
1.8.1 Ampara	- Ampara	1.8.13 Kilinochchi	- Kilinochchi
1.8.2 Avissawella	- Colombo	1.8.14 Kuliypitiya	- Kurunegala
1.8.3 Balangoda	- Rathnapura	1.8.15 Kurunegala	- Kurunegala
1.8.4 Balapitiya	- Galle	1.8.16 Maho	- Kurunegala
1.8.5 Chilaw	- Puttalam	1.8.17 Mannar	- Mannar
1.8.6 Elpitiya	- Galle	1.8.18 Matale	- Matale
1.8.7 Embilipitiya	- Rathnapura	1.8.19 Mullaitivu	- Mullaitivu
1.8.8 Gampaha	- Gampaha	1.8.20 Nuwara Eliya	- Nuwara Eliya
1.8.9 Gampola	- Kandy	1.8.21 Panadura	- Kalutara
1.8.10 Hambantota	- Hambantota	1.8.22 Point Pedro	- Jaffna
1.8.11 Hatton	- Nuwara Eliya	1.8.23 Puttalam	- Puttalam
1.8.12 Kalmunai	- Ampara		

PRISON INSTITUTIONS OF SRI LANKA - 2013

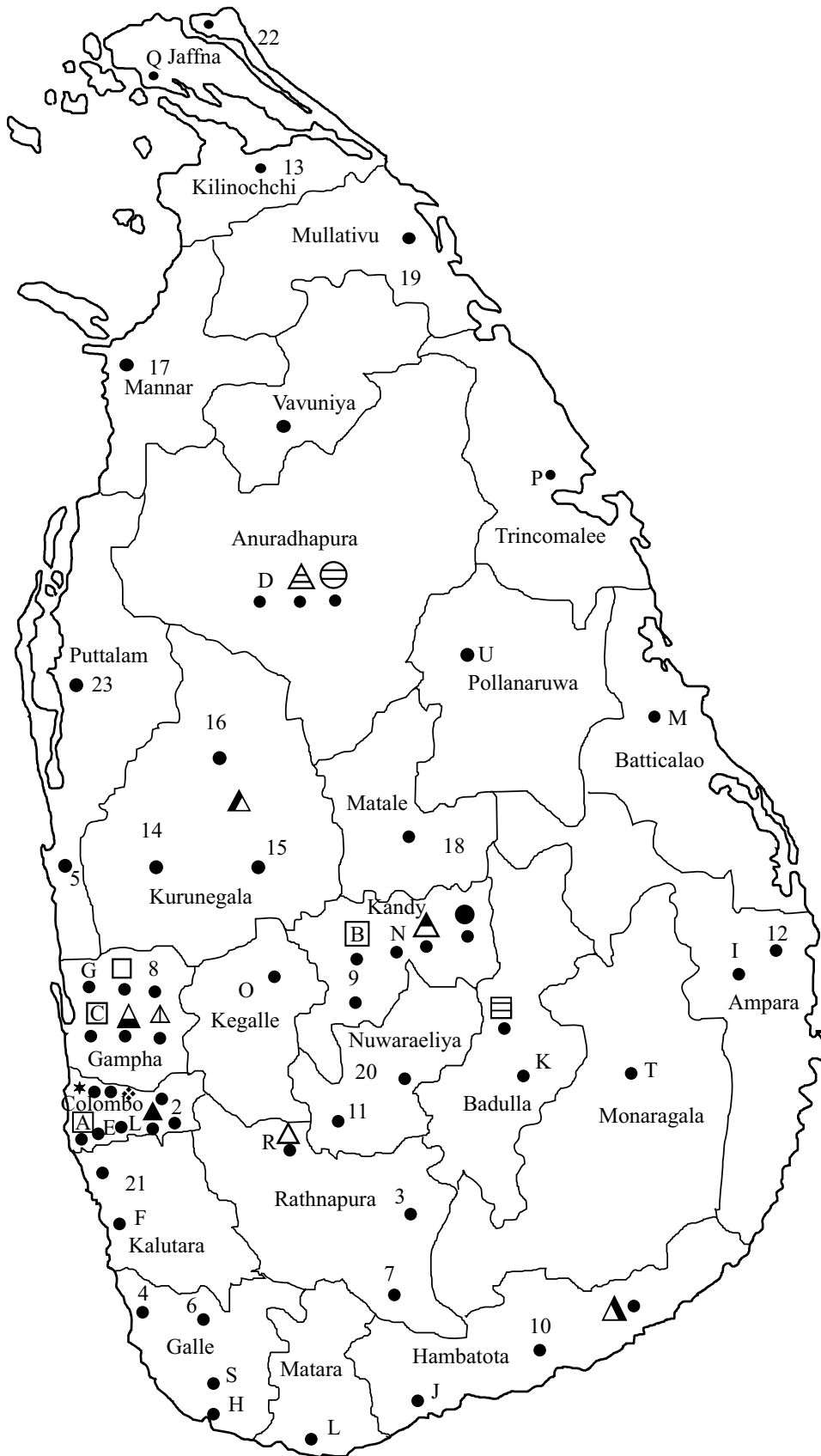

Details of Institutions are given in page 5

★ **PRISON HEADQUARTERS**

❖ **C.R.T.C.**

Centre for Research Training
in corrections











CLOSED PRISONS

- A** Welikada
- B** Bogambara
- C** Mahara



REMAND PRISONS

- D - Anuradhapura
- E - Colombo
- F - Kalutara
- G - Negambo
- H - Galle
- I - New Magazine
- J - Tangalle
- K - Badulla
- L - Matara
- M - Batticoloa
- N - Kandy
- O - Kegalle
- P - Trincomalee
- Q - Jaffna
- R - Kuruwita
- S - Boossa
- T - Monaragala
- U - Polonnaruwa
- V - Wariyapola
- W - Vavuniya



WORK CAMPS

-  - Homagama
-  - Mitirigala
-  - Wanawasala (Nawodawa)
-  - Werawila
-  - Anuradapura
-  - Kuruwita
-  - Wariyapola
-  - Hangilipola
-  - Kandewatte
-  - Thunkuma

OPEN PRISON CAMPS

-  - Pallekelle
-  - Anuradhapura

**CORRECTIONAL CENTRES
FOR YOUTHFUL OFFENDERS**

-  - Pallansena - C.C.Y.O. and T.S.Y.O.
-  - Taldena - C.C.Y.O.
-  - Ambepussa T.S.Y.O.

LOCK-UPS

- | | | |
|------------------|------------------|-------------------|
| 1 - Ampara | 10 - Hambantota | 19 - Mullaitivu |
| 2 - Awissawella | 11 - Hatton | 20 - Nuwara Eliya |
| 3 - Balangoda | 12 - Kalmunai | 21 - Panadura |
| 4 - Balapitya | 13 - Kilinochchi | 22 - Point Pedro |
| 5 - Chilaw | 14 - Kuliypitiya | 23 - Puttalam |
| 6 - Elpitiya | 15 - Kurunegala | |
| 7 - Embilipitiya | 16 - Maho | |
| 8 - Gampaha | 17 - Mannar | |
| 9 - Gampola | 18 - Matale | |

DEPARTMENTAL STAFF

Staff Officers Emblems

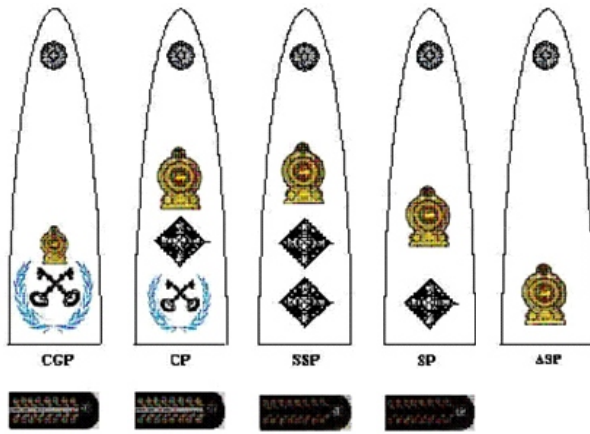

- CGP – Commissioner General of Prisons
- CP – Commissioner of Prisons
- SSP – Senior Superintendent of Prisons
- SP – Superintendent of Prisons
- ASP – Assistant Superintendent of Prisons

Executive Officers Emblems

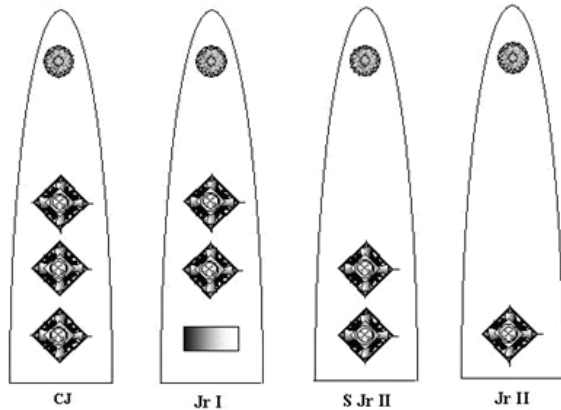

- CJ – Chief Jailer
- Jr I – Jailer Class I
- S Jr II – Senior Jailer Class II
- Jr II – Jailer Class II

Disciplinary Staff Emblems

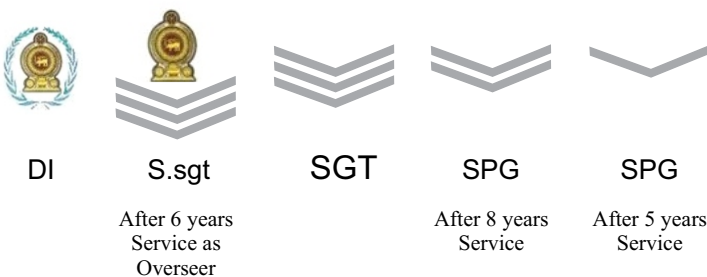

- DI – Drill Instructor
- S.sgt – Senior Sargent
- SGT – Sargent
- SPG – Senior Prison Guard

Other Staff Emblems

AI AO IF T IS SK MD VI D

- AI - Agriculture Instructor
- AO - Agriculture Overseer
- IF - Industrial Forman
- T - Technician
- IS - Industrial Supervisor
- SK - Store Keeper
- MD - Motor Driver
- VI - Vocational Instructor
- D - Dispenser

STRUCTURE OF THE PRISONS DEPARTMENT

COMMISSIONER GENERAL OF PRISONS

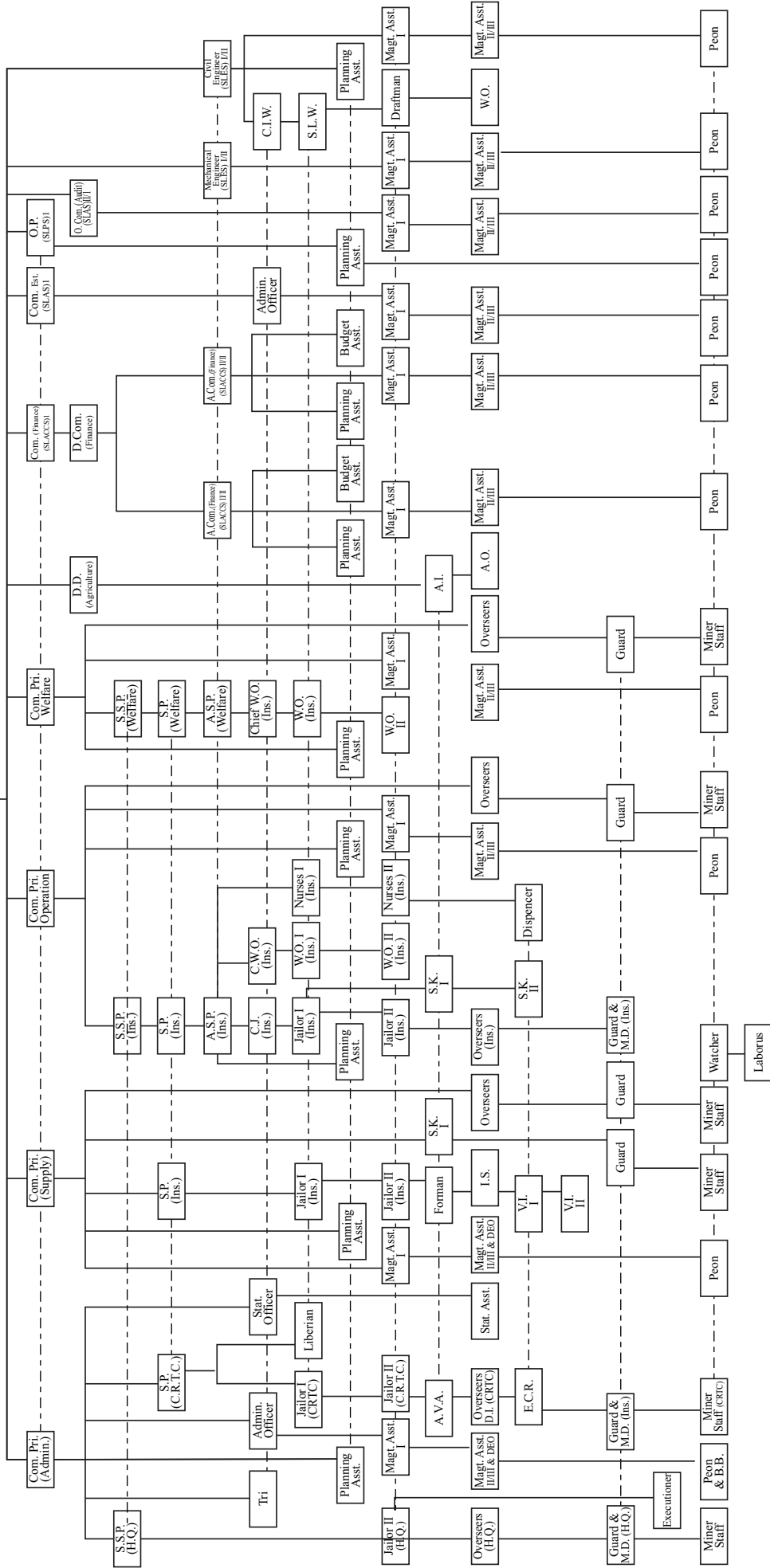

Abbreviations Carder

Commissioner General of Prisons	1	Civil Engineer	2	Budget Assit. - Budget Assistant	2	Forman	15
Com. Pri. - Commissioner Prison	4	Tri. - Translator	2	Jailor - ii	271	A.O. - Agriculture Overseers	27
Com. Est. - Commissioner Establishment	1	Admin. Officer - Administrative Officer	2	Magt. Assit. - Management Assistant	62	E.C.R. - Electro Cardiographic Recorder	1
Com. Finance - Commissioner Finance	1	Stat. Officer - Statistical Officer	1	W.O. - Welfare Officer - ii	79	Dispensor	80
D.P. - Director Planning	1	C.J. - Chief Jailor	8	Nurse - ii	47	I.A. - Industrial Supervisor	14
D.D. - Deputy Director Agriculture	1	C.W.O. - Chief Welfare Officer	3	Draftsman	1	Prison Guard	4,291
D.Comm. - Deputy Commissioner (Finance)	1	C.I.W. - Chif Inspector of Work	1	A.V.A. - Audio Visual Assistant	1	M.D. - Motor Driver	142
D.Comm. - Deputy Commissioner (Audit)	1	Jailor - i	40	S.K. - Store Keeper	44	V.I. - Vocational Instructor	97
S.S.P. - Senior Superintendent of Prison	4	Librarian	1	A.I. - Agriculture Instructors	10	Executioner	2
S.P. - Superintendent of Prison	11	W.O. - Welfare Officer - i	8	Prison Overseer	842	Peon	19
A.S.P. - Assistant Superintendent of Prison	23	Nurses - i	4	W.O. - Work Overseers	3	B.B. - Book Binder	1
A.Com. - Assistant Commissioner (Finance)	2	S.I.W. - Sub Inspector of Work	3	DEO. - Data Entry Operator	3	Watcher	52
Mechanical Engineer	1	Planning Assit. - Planning Assistant	40	D.I. - Drill Instructor	3	Labourers	35
(H.Q.) - Head Quarters	(Ins) - Institutions	C.R.T.C - Centre for Research and Training in Corrections	(Ind) - Industries	(i) - Class - i	(ii) - Class - ii	(iii) - Class - iii	

Note :- Administration of officers in all institutions are directly under commissioner administration.

Table 2.1

**THE DEPARTMENTAL STAFF CLASSIFIED ACCORDING TO GRADES
AS ON 31ST DECEMBER EACH YEAR UNDER REFERENCE, 2010 - 2013**

GRADE	Year			
	2010	2011	2012	2013
<u>PRISONS DEPARTMENT OFFICERS (a) - (d)</u>				
(a). Uniform Staff				
Commissioner General of Prisons	1	1	1	1
Commissioner of Prisons	3	3	3	2
Superintendent of Prisons (Special Grade)	1	1	2	1
Superintendent of Prisons	9	9	8	9
Superintendent of Prisons (Industries)	-	-	-	1
Asst. Superintendent of Prisons	16	15	14	13
Chief Jailors	7	7	7	15
Jailors (Class 1)	20	38	36	34
Jailors (Class 11) / Male & Female	186	164	219	270
Prison Overseers / Male & Female	521	438	420	706
Prison Guards / Male & Female	3,884	3,766	3,953	4,133
Male Nurses	36	38	40	37
Dispensers	26	21	37	74
Agricultural Instructors	6	3	3	8
Agricultural Overseers	7	6	6	1
Industrial Foremans	9	7	6	19
Vocational Instructors & Technicians	73	67	67	60
Industrial Supervisors	1	-	-	4
Drill Instructors	2	2	2	2
Store Keepers	43	37	41	-
Motor Mechanics	2	2	1	-
Van & Tractor Drivers	107	126	130	157
Executioners	1	-	-	-
Sub Total	4,961	4,751	4,996	5,547
(b). Non - Uniform Staff				
Commissioner of Prisons - (S.L.A.S)	-	-	-	1
Commissioner of Prisons - Welfare	1	-	-	-
Deputy Commissioner of Prisons - (S.L.A.S)	1	1	-	-
Superintendent of Prisons (Special Grade) - Welfare	-	-	-	-
Superintendent of Prisons - Welfare	-	-	-	-
Asst. Superintendent of Prisons - Welfare	-	2	2	2
Chief Welfare Officers	2	-	-	-
Prison Welfare Officers - (Class 1)	4	4	3	8
Planning Assistants	20	19	19	-
Development Officers	-	-	-	44
Prison Welfare Officers - (Class 2)	65	74	115	119
*Inspector & Sub Inspector of Works	2	2	1	-
*Draughtsmans	-	-	1	1
Computer Operators	3	3	2	2
Electro Cardiographers	1	1	1	1
Audio Visual Assistants	-	-	-	-
Work Overseers	-	-	-	-
Watchers	31	45	50	52
Pump Attendants	1	1	1	1
Cycle Orderlies	-	-	-	-
Labourers	22	28	35	35
Sub Total	153	180	230	266

*Comes Under Technological Services

Table 2.1 - Contd.

**THE DEPARTMENTAL STAFF CLASSIFIED ACCORDING TO GRADES AS ON 31ST
DECEMBER EACH YEAR UNDER REFERENCE, 2010 - 2013**

GRADE	Year			
	2010	2011	2012	2013
(c). Officers from the Combined Services				
Administrative Officer	2	2	2	-
Translator	1	1	1	1
Management Assistant	45	53	46	43
Book - Keeper	-	-	-	-
Shroff	-	-	-	-
Stenographers & Typist	-	-	-	-
Binder	-	-	-	-
K.K.S.' ,Cycle Orderlies & Messenger	10	9	13	35
Labourers & Other	-	-	-	-
Sub Total	58	65	62	79
(d). Officers from the Other Services				
Engineer	2	2	3	3
Accountant	5	4	4	2
Director (Planning)	1	1	1	1
Assistant Director(Planning)	-	-	-	1
Chief Inspector of Work	1	1	1	1
Sub Total	9	8	9	8
(e). Officers Posted from Other Departments				
Medical Officer	20	24	24	20
Registered Medical Practitioner	23	30	30	25
Statistical Officer	1	1	1	1
Statistical Assistant	-	-	-	-
Medical Lab Technician	4	4	4	1
Budget Assistant	1	1	1	-
Other	-	-	-	-
Sub Total	49	60	60	47
Grand Total	5,230	5,064	5,357	5,947

Note : Clerical Staff Includes Book - Keepers, Shorffs, Stenographers & Typiests for the Year 2005 Onwards.

Above posts are called State Management Service for the year 2005 Onwards.

**Cycle Orderlies are not Included from the year 2006 & onwards.

Source : Department of Prison

Table 2.2

**THE DEPARTMENTAL STAFF TRAINED AT THE CENTER FOR RESEARCH AND TRAINING IN CORRECTIONS
TRAINING COURSES, 2009 - 2013**

Type of Officers	Year														
	2009			2010			2011			2012			2013		
	Male	Female	Total	Male	Female	Total	Male	Female	Total	Male	Female	Total	Male	Female	Total
New Recruits Trained															
1. Superintendents / Asst. Superintendents	-	-	-	-	-	-	-	-	-	-	-	-	-	-	-
2. Welfare Officers	-	-	-	-	-	-	35	5	40	-	-	-	-	-	-
3. Jailors	-	-	-	-	-	-	55	-	55	-	-	-	-	-	-
4. Prison Guards	1,180	69	1,249	18	-	18	-	-	-	395	23	418	290	41	331
5. Other Grades	-	-	-	-	-	-	26	3	29	9	-	9	156	7	163
Total	1,180	69	1,249	18	-	18	116	8	124	404	23	427	446	48	494
In Service Officers Trained															
1. Superintendents / Asst. Superintendents	-	-	-	22	-	22	25	-	25	117	-	117	8	-	8
2. Senior Welfare Officers	-	-	-	3	-	3	-	-	-	-	-	-	-	-	-
3. Chief Jailors / Jailors - (Class -1)	-	-	-	16	-	16	41	-	41	70	-	70	20	-	20
4. Jailors	12	3	15	24	-	24	98	-	98	81	-	81	55	4	59
5. Welfare Officers	-	-	-	5	1	6	52	10	62	152	36	188	11	2	13
6. Prison Overseers	2	-	2	16	1	17	183	3	186	146	10	156	129	-	129
7. Prison Guards	30	5	35	26	-	26	668	50	718	662	63	725	350	66	416
8. Other Grades	-	-	-	-	1	1	107	-	107	175	14	189	-	-	-
Total	44	8	52	112	3	115	1,174	63	1,237	1,403	123	1,526	573	72	645

Note :- An Individual has Followed at least one Internal course or more than one.

Source : Department of Prison

UNCONVICTED PRISONERS

UNCONVICTED PRISONERS, 2009 - 2013

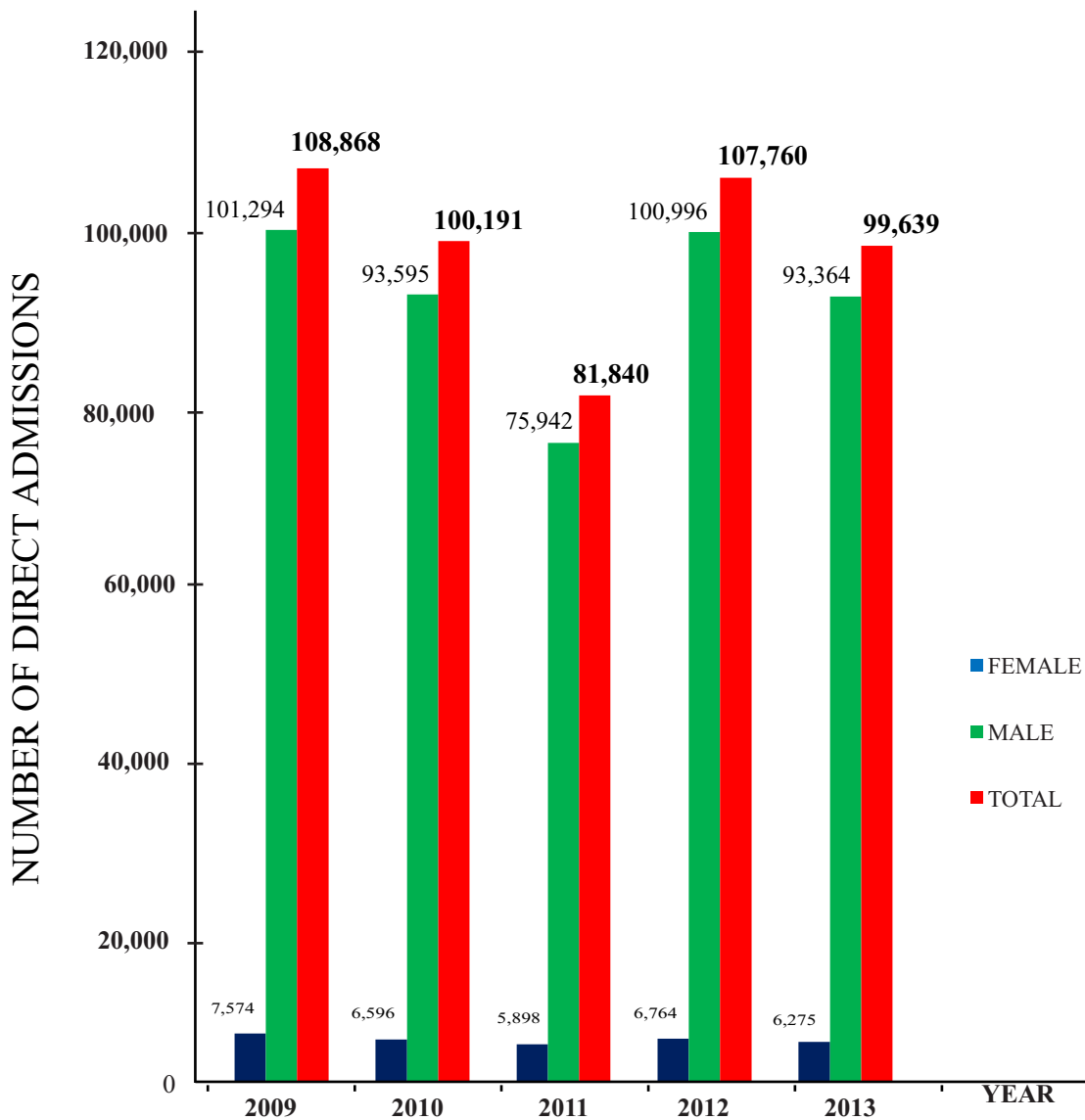

Table 3.1

DIRECT ADMISSIONS OF UNCONVICTED PRISONERS BY INSTITUTIONS, 2009 - 2013

Institution	2009			2010			2011			2012			2013		
	Male	Female	Total	Male	Female	Total	Male	Female	Total	Male	Female	Total	Male	Female	Total
	Welikada Prison	4,641	2,819	7,460	3,363	2,011	5,374	3,051	1,818	4,869	3,125	2,072	5,197	1,762	1,941
Colombo Remand Prison	7,844	-	7,844	6,872	-	6,872	6,928	-	6,928	7,175	-	7,175	5,463	-	5,463
New Magazine Remand Prison	13,069	-	13,069	12,209	-	12,209	-	-	-	9,557	-	9,557	9,429	-	9,429
Mahara Prison	5,167	-	5,167	4,600	-	4,600	4,488	-	4,488	6,194	-	6,194	7,986	-	7,986
Bogambara Prison	3,977	-	3,977	4,080	-	4,080	3,489	-	3,489	4,003	-	4,003	3,638	-	3,638
Kandy Remand Prison	4,240	664	4,904	3,545	540	4,085	3,328	525	3,853	3,906	709	4,615	3,148	572	3,720
Jaffna Remand Prison	2,508	347	2,855	2,461	194	2,655	2,573	169	2,742	2,734	127	2,861	2,872	170	3,042
Anuradhapura Remand Prison	7,533	496	8,029	5,826	461	6,287	4,424	265	4,689	7,127	473	7,600	5,496	391	5,887
Badulla Remand Prison	4,125	205	4,330	3,694	246	3,940	3,597	145	3,742	3,156	206	3,362	3,473	155	3,628
Batticaloa Remand Prison	2,741	150	2,891	2,916	187	3,103	2,532	141	2,673	3,356	168	3,524	3,482	253	3,735
Galle Remand Prison	4,488	396	4,884	5,103	463	5,566	4,297	537	4,834	6,033	308	6,341	4,860	214	5,074
Matara Remand Prison	3,380	164	3,544	2,315	130	2,445	2,610	157	2,767	3,880	245	4,125	2,966	163	3,129
Tangalle Remand Prison	2,440	161	2,601	2,291	126	2,417	2,183	95	2,278	3,122	180	3,302	3,339	149	3,488
Negambo Remand Prison	7,262	711	7,973	7,119	608	7,727	6,961	618	7,579	9,269	694	9,963	8,253	823	9,076
Trincmalee Remand Prison	2,059	134	2,193	2,169	52	2,221	2,103	106	2,209	2,474	151	2,625	2,115	89	2,204
Kegalle Remand Prison	3,922	-	3,922	4,139	-	4,139	3,890	-	3,890	4,705	-	4,705	4,205	-	4,205
Kalutara Remand Prison	7,342	496	7,838	4,727	323	5,050	4,659	287	4,946	5,463	352	5,815	5,703	450	6,153
Kuruwita Remand Prison	4,855	315	5,170	4,174	277	4,451	4,020	274	4,294	5,464	321	5,785	4,009	208	4,217
Polonnaruwa Remand Prison	2,183	77	2,260	2,365	235	2,600	1,732	94	1,826	2,051	118	2,169	1,898	107	2,005
Monaragala Remand Prison	3,282	154	3,436	3,343	144	3,487	3,006	153	3,159	2,821	159	2,980	2,495	111	2,606
Boossa Prison	-	-	-	-	-	-	-	-	-	-	-	-	-	-	-
Wariyapola Remand Prison	3,916	261	4,177	3,854	425	4,279	3,696	373	4,069	3,947	401	4,348	3,421	350	3,771
Vavuniya Remand Prison	320	24	344	2,430	174	2,604	2,375	141	2,516	1,434	80	1,514	3,351	129	3,480
Total	101,294	7,574	108,868	93,595	6,596	100,191	75,942	5,898	81,840	100,996	6,764	107,760	93,364	6,275	99,639

Source : Department of Prison. Note : In 2011 No information was received from the New Magazine Remand Prison as all documents were set on fire and destroyed by the Prisoners Riot as reported by the Superintendent of Prisons New Magazine.

Table 3.2

DIRECT ADMISSIONS OF UNCONVICTED PRISONERS ACCORDING TO AGE GROUPS, 2009 - 2013

Age Group	2009			2010			2011			2012			2013		
	Male	Female	Total	Male	Female	Total	Male	Female	Total	Male	Female	Total	Male	Female	Total
Under 16 years	1,131	315	1,446	1,121	315	1,436	951	202	1,153	1,568	429	1,997	-	-	-
16 and under 22 years	13,857	976	14,833	13,455	854	14,309	9,830	721	10,551	10,448	1,182	11,630	7,215	784	7,999
22 and under 30 years	35,237	1,887	37,124	34,426	1,786	36,212	25,956	1,681	27,637	25,305	1,703	27,008	24,028	1,464	25,492
30 and under 40 years	24,712	2,528	27,240	24,316	1,830	26,146	19,352	1,556	20,908	29,244	1,652	30,896	34,721	1,882	36,603
40 and under 50 years	16,101	1,159	17,260	13,254	1,081	14,335	11,720	938	12,658	21,004	1,164	22,168	17,736	1,243	18,979
50 and 60 years	7,001	495	7,496	5,318	523	5,841	6,116	628	6,744	10,437	486	10,923	7,448	699	8,147
60 years and above	3,255	214	3,469	1,705	207	1,912	2,017	172	2,189	2,990	148	3,138	2,216	203	2,419
Total	101,294	7,574	108,868	93,595	6,596	100,191	75,942	5,898	81,840	100,996	6,764	107,760	93,364	6,275	99,639

Source : Department of Prisons

Table 3.3

DIRECT ADMISSIONS OF UNCONVICTED PRISONERS ACCORDING TO LITERACY, 2009 - 2013

	2009			2010			2011			2012			2013		
	Male	Female	Total	Male	Female	Total	Male	Female	Total	Male	Female	Total	Male	Female	Total
No Schooling	8,422	818	9,240	7,631	648	8,279	4,067	611	4,678	7,580	956	8,536	5,032	827	5,859
Grade 1 – 5	22,676	2,518	25,194	21,623	1,381	23,004	12,496	1,437	13,933	19,188	1,880	21,068	16,684	1,714	18,398
Passed Grade 5	24,094	1,380	25,474	21,308	1,670	22,978	15,661	1,461	17,122	27,203	1,580	28,783	21,169	1,461	22,630
Passed Grade 8	28,272	1,864	30,136	25,256	1,576	26,832	25,962	1,495	27,457	30,598	1,303	31,901	27,885	1,489	29,374
Passed G.C.E. (O/L)	13,847	725	14,572	14,942	995	15,937	12,657	614	13,271	12,588	733	13,321	17,166	600	17,766
Passed G.C.E. (A/L)	3,868	252	4,120	2,690	299	2,989	4,065	186	4,251	3,108	267	3,375	3,355	141	3,496
Graduate	104	17	121	135	22	157	219	24	243	443	42	485	386	21	407
Others	11	-	11	10	5	15	815	70	885	288	3	291	1,687	22	1,709
Total	101,294	7,574	108,868	93,595	6,596	100,191	75,942	5,898	81,840	100,996	6,764	107,760	93,364	6,275	99,639

Source : Department of Prisons

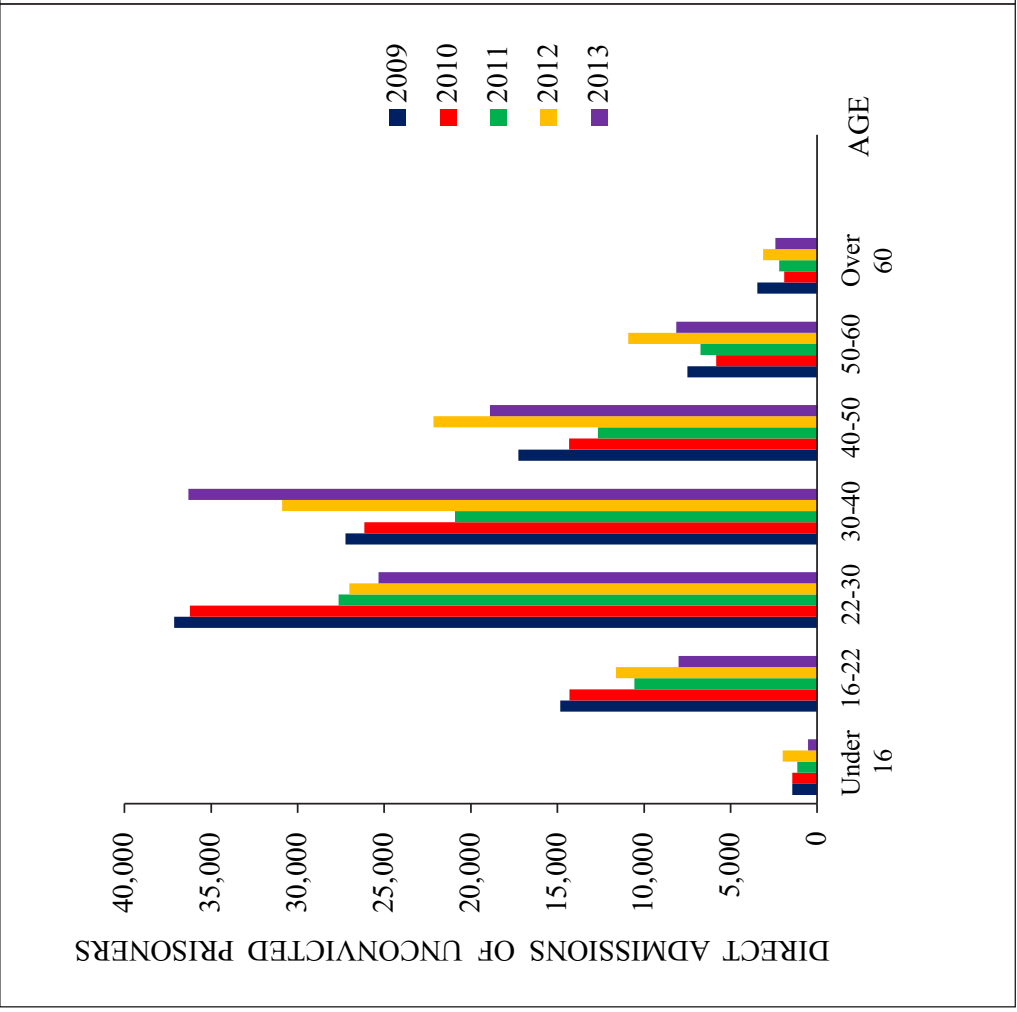
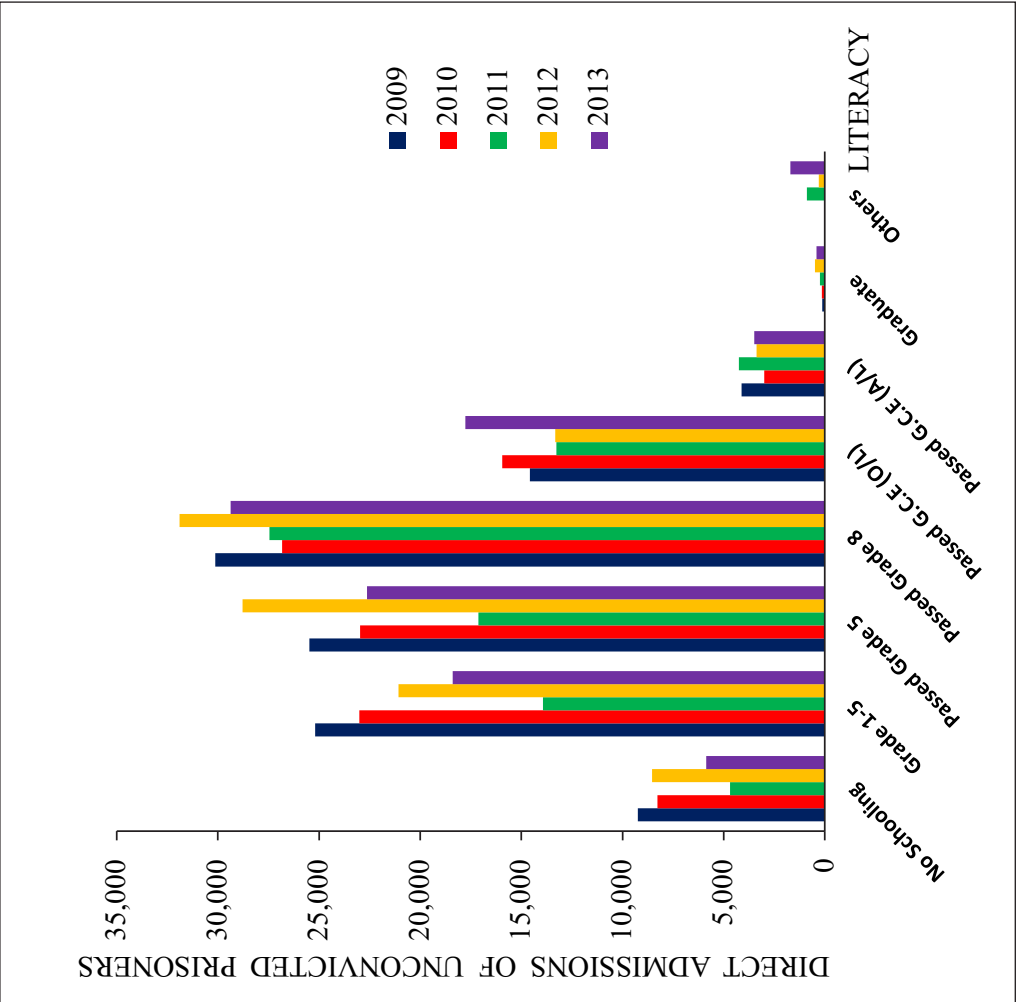

Table 3.4

DIRECT ADMISSIONS OF UNCONVICTED PRISONERS BY RACE AND THE PERCENTAGE DISTRIBUTIONS, 2009 - 2013

Year	All Races	Race															
		Sinhalese		Tamil			Moore			Others			%				
		Number	%	Sri Lankan	Indian	%	Sri Lankan	Indian	%	Malay	Burgher	%					
2009	108,868	75,322	69.2	18,221	16.7	2,218	2.0	12,800	11.8	67	0.1	102	0.1	57	0.0	81	0.1
2010	100,191	66,449	66.2	18,800	18.8	1,801	1.8	12,733	12.7	161	0.2	109	0.1	72	0.1	66	0.1
2011	81,840	56,934	69.6	13,747	16.8	1,597	2.0	9,243	11.2	18	0.0	155	0.2	57	0.1	89	0.1
2012	107,760	76,884	71.4	18,785	17.5	3,556	3.3	8,116	7.5	15	0.0	123	0.1	36	0.0	245	0.2
2013	99,639	68,967	69.4	17,859	17.9	1,365	1.4	11,029	11.0	48	0.0	111	0.1	54	0.0	206	0.2

Source : Department of Prisons

Table 3.5

DIRECT ADMISSIONS OF UNCONVICTED PRISONERS BY RELIGION AND THE PERCENTAGE DISTRIBUTIONS , 2009 - 2013

Year	All Religions	Religion											
		Buddhist	%	Hindu	%	Islam	%	Roman Catholic	%	Other Christians	%	Others	%
2009	108,868	68,665	63.1	18,213	16.7	13,000	11.9	7,323	6.7	1,584	1.5	83	0.1
2010	100,191	62,646	62.5	17,517	17.5	12,287	12.3	6,728	6.7	950	0.9	63	0.1
2011	81,840	53,192	65.0	13,573	16.6	9,203	11.2	4,234	5.2	1,523	1.9	115	0.1
2012	107,760	71,012	65.898	19,077	17.703	10,070	9.3	5,243	4.9	2,170	2.0	188	0.2
2013	99,639	63,541	63.8	16,330	16.5	11,221	11.2	6,505	6.5	1,694	1.7	348	0.3

Source : Department of Prisons

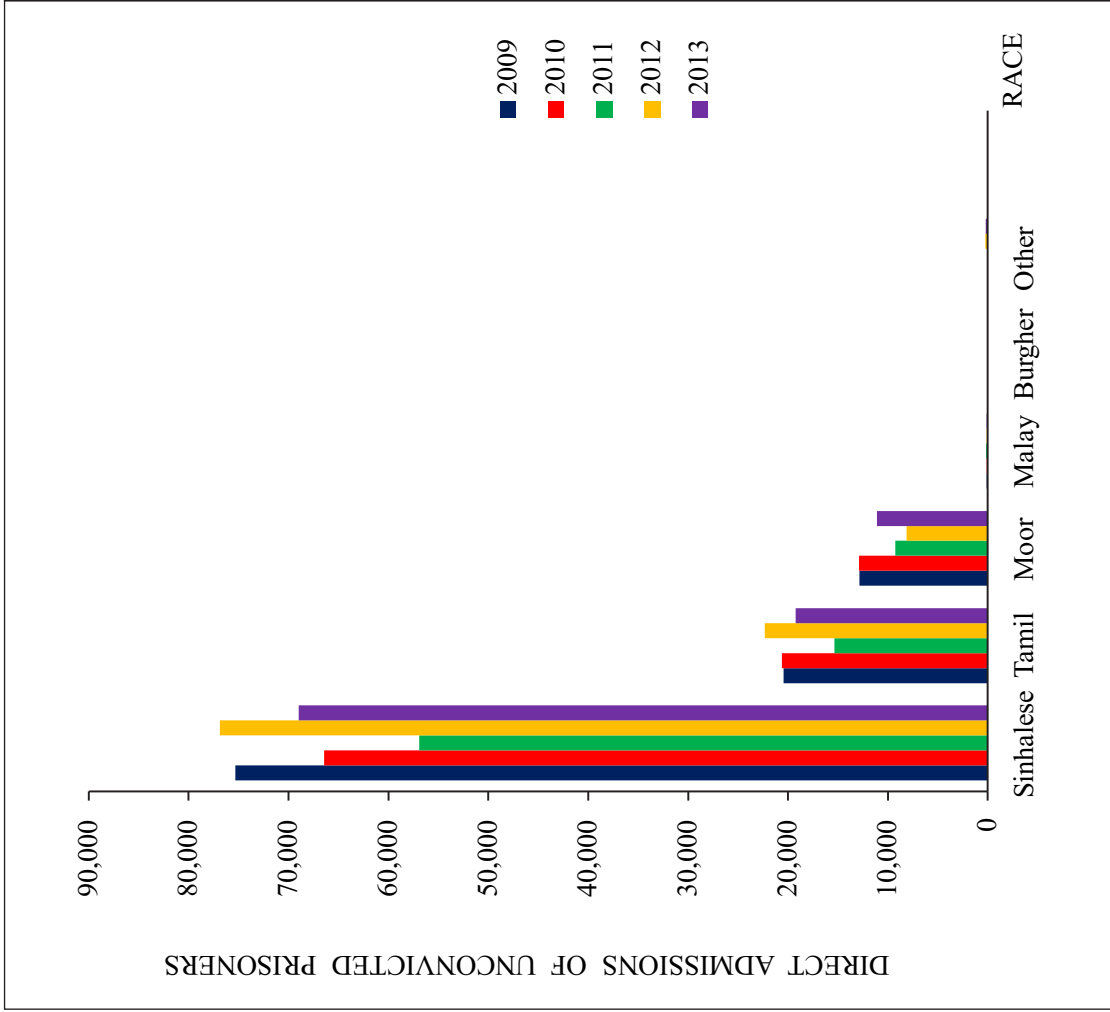
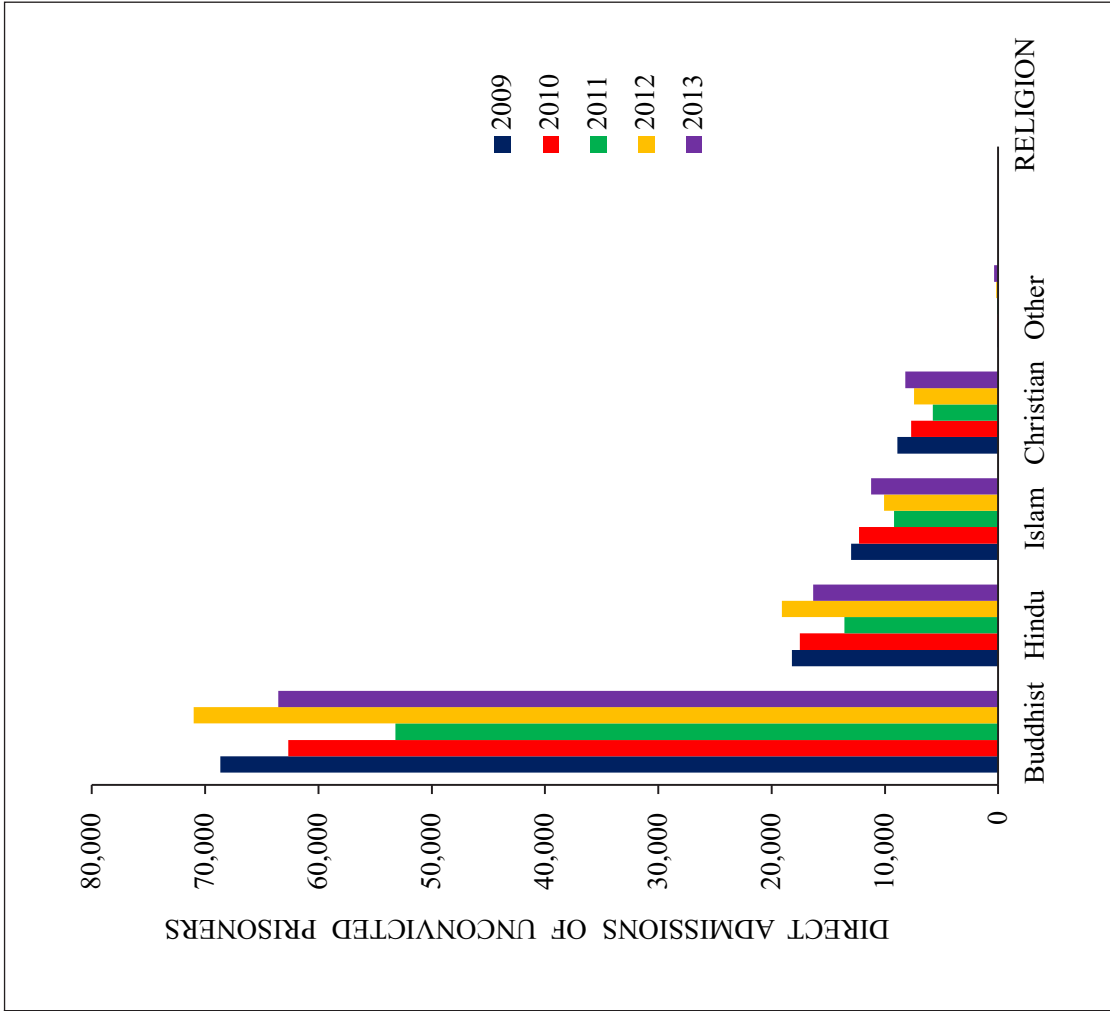

Table 3.6

DIRECT ADMISSIONS OF UNCONVICTED PRISONERS ACCORDING TO MARITAL STATUS, 2009 - 2013

Marital Status	2009			2010			2011			2012			2013		
	Male	Female	Total	Male	Female	Total	Male	Female	Total	Male	Female	Total	Male	Female	Total
Never Married	32,332	1,232	33,564	33,655	1,874	35,529	23,734	1,063	24,797	29,196	1,370	30,566	22,707	1,202	23,909
Married	63,661	5,752	69,413	55,540	3,589	59,129	49,117	4,216	53,333	66,099	4,768	70,867	66,272	4,474	70,746
Widowed	616	225	841	882	524	1,406	479	255	734	1,054	178	1,232	466	225	691
Divorced	3,176	201	3,377	2,503	428	2,931	1,945	217	2,162	2,335	299	2,634	1,924	203	2,127
Legally Separated	1,509	164	1,673	1,015	181	1,196	667	147	814	2,312	149	2,461	1,995	171	2,166
Total	101,294	7,574	108,868	93,595	6,596	100,191	75,942	5,898	81,840	100,996	6,764	107,760	93,364	6,275	99,639

Source : Department of Prisons

Table 3.7

STATISTICS RELATING TO THE CUSTODY OF REMAND PRISONERS, 2010 - 2013

Name & Lockup	2010		2011		2012		2013	
	Total No. of Lockups Under SP	No. of Admissions	Total No. of Lockups Under SP	No. of Admissions	Total No. of Lockups Under SP	No. of Admissions	Total No. of Lockups Under SP	No. of Admissions
Kalutara Remand Prison	1		1		1		1	
Kalutara		-		-		-		-
Negombo Remand Prison	2		2		2		2	
Chilaw		3,511		3,589		3,960		2,540
Puttalam		6,300		6,425		7,132		4,486
Bogambara Prison	3		3		3		3	
Matale		7,687		5,541		8,946		8,449
Gampola		1,253		960		2,034		2,085
Hatton		2,786		1,521		1,956		1,944
Mahara Prison	1		1		1		1	
Gampaha		8,411		11,339		-		-
Jaffna Remand Prison	3		3		3		3	
Point Pedro		-		-		-		-
Mullativu		-		-		-		-
Killinochchi		-		-		-		-
Galle Remand Prison	2		2		2		2	
Balapitiya		7,614		6,008		7,030		6,396
Elpitiya		6,891		6,252		4,444		4,347
Batticoloa Remand Prison	1		1		1		1	
Kalmunai		2,019		1,961		1,759		1,845
A'pura Remand Prison	1		1		1		1	
Vavuniya		-		-		-		-
Mannar		1,190		1,278		641		494
Badulla Remand Prison	1		1		1		1	
Nuwaraeliya		4,780		4,946		5,244		4,751
Tangalle Remand Prison	2		2		2		2	
Hambantota		3,301		5,865		5,733		4,549
Embilipitiya		10,042		10,470		7,028		4,648
Kuruwita Remand Prison	2		2		2		2	
Balangoda		1,030		1,018		1,096		802
Avissawella		8,208		9,101		2,144		-
Wariyapola Prison	2		2		2		2	
Kuliyapitiya		6,371		4,198		3,575		3,438
Maho		3,333		4,477		3,596		3,024
Kegalla Remand Prison	1		1		1		1	
Kurunegala		797		1,793		1,908		1,720
Monaragala Prison	1		1		1		1	
Ampara		2,796		2,712		3,142		2,634
Total	23	88,320	23	89,454	23	71,368	23	58,152

Source : Department of Prisons

Table 3.8

PERIOD SPENT ON REMAND BY PRISONERS AWAITING TRIAL - 2013

	Under 6 Months		6 – 12 Months		12 – 18 Months		18 Months to 2 years		Over 2 years		Total		TOTAL
	Male	Female	Male	Female	Male	Female	Male	Female	Male	Female	Male	Female	
On 2013.03.31													
High Courts	341	10	157	12	127	14	98	15	151	15	874	66	940
District Courts	302	20	60	4	39	-	31	2	18	3	450	29	479
Magistrate Courts	4,251	419	2,452	134	1,601	52	759	41	561	51	9,624	697	10,321
Other Courts	39	8	24	6	13	2	14	1	6	-	96	17	113
Total	4,933	457	2,693	156	1,780	68	902	59	736	69	11,044	809	11,853
On 2013.06.30													
High Courts	229	21	108	8	117	7	85	7	165	17	704	60	764
District Courts	319	11	343	4	53	3	32	-	5	3	752	21	773
Magistrate Courts	4,116	490	2,311	120	1,127	57	605	42	499	51	8,658	760	9,418
Other Courts	45	6	29	3	14	-	9	1	11	1	108	11	119
Total	4,709	528	2,791	135	1,311	67	731	50	680	72	10,222	852	11,074
On 2013.09.30													
High Courts	332	15	140	9	77	13	108	5	121	11	778	53	831
District Courts	352	18	186	9	93	3	66	2	27	3	724	35	759
Magistrate Courts	5,093	456	2,411	128	1,007	70	534	96	398	67	9,443	817	10,260
Other Courts	62	8	36	5	22	2	16	-	3	1	139	16	155
Total	5,839	497	2,773	151	1,199	88	724	103	549	82	11,084	921	12,005
On 2013.12.31													
High Courts	291	16	121	9	116	6	80	4	91	14	699	49	748
District Courts	305	14	144	7	73	4	41	2	30	3	593	30	623
Magistrate Courts	4,322	326	2,125	101	938	38	417	24	229	37	8,031	526	8,557
Other Courts	46	2	23	3	15	1	10	-	4	-	98	6	104
Total	4,964	358	2,413	120	1,142	49	548	30	354	54	9,421	611	10,032

Source ; Department of Prisons

Table 3.9

**DIRECT ADMISSIONS OF UNCONVICTED PRISONERS BY DISTRICTS , RATE PER HUNDRED THOUSAND
POPULATION AND PERCENTAGE DISTRIBUTION, 2011 - 2013**

District	2011					2012					2013					
	Estimated Population In 000' s	Number Admitted	Rate per 100000 Population	Percentage Distribution by District	Estimated Population In 000' s	Number Admitted	Rate per 100000 Population	Percentage Distribution by District	Estimated Population In 000' s	Number Admitted	Rate per 100000 Population	Percentage Distribution by District	Estimated Population In 000' s	Number Admitted	Rate per 100000 Population	Percentage Distribution by District
Colombo	2,584	10,281	397.9	12.6	2,328	20,280	871.1	18.8	2,326	22,361	961.3	22.4	2,326	22,361	961.3	22.4
Gampaha	2,191	8,663	395.4	10.6	2,299	11,161	485.5	10.3	2,313	10,224	442.0	10.3	2,313	10,224	442.0	10.3
Kalutara	1,144	5,424	474.1	6.6	1,224	6,202	506.7	5.8	1,227	4,648	378.8	4.7	1,227	4,648	378.8	4.7
Kandy	1,447	5,229	361.4	6.4	1,371	6,339	462.4	5.9	1,384	5,299	382.9	5.3	1,384	5,299	382.9	5.3
Matale	504	2,080	412.7	2.6	482	2,245	465.8	2.0	489	2,360	482.6	2.4	489	2,360	482.6	2.4
Nuwaraeliya	768	1,943	253.0	2.4	708	748	105.6	0.7	719	1,132	157.4	1.1	719	1,132	157.4	1.1
Galle	1,096	4,662	425.4	5.7	1,063	6,476	609.2	6.0	1,068	5,349	500.8	5.4	1,068	5,349	500.8	5.4
Matarata	847	3,267	385.7	4.0	810	4,428	546.7	4.1	819	3,087	376.9	3.1	819	3,087	376.9	3.1
Hambantota	576	1,581	274.5	1.9	598	2,261	378.1	2.1	606	2,006	331.0	2.0	606	2,006	331.0	2.0
Jaffna	617	2,868	464.8	3.5	583	3,309	567.6	3.1	589	3,087	524.1	3.1	589	3,087	524.1	3.1
Mannar	105	723	688.6	0.9	99	627	633.3	0.6	101	965	955.4	1.0	101	965	955.4	1.0
Mulathivu	144	771	535.4	0.9	92	716	778.3	0.7	93	814	875.3	0.8	93	814	875.3	0.8
Vavuniya	177	1,048	592.1	1.3	171	2,081	1,217.0	1.9	174	1,382	794.3	1.4	174	1,382	794.3	1.4
Kilinochchi	160	612	382.5	0.8	114	706	619.3	0.6	116	830	715.5	0.8	116	830	715.5	0.8
Batticaloa	550	1,649	299.8	2.0	525	2,378	453.0	2.2	529	2,184	412.9	2.2	529	2,184	412.9	2.2
Ampara	654	2,483	379.7	3.0	648	3,605	556.3	3.3	658	3,031	460.6	3.0	658	3,031	460.6	3.0
Trincomalee	380	2,142	563.7	2.6	378	2,399	634.7	2.2	384	1,888	491.7	1.9	384	1,888	491.7	1.9
Kurunegala	1,577	6,971	442.0	8.5	1,618	7,687	475.1	7.1	1,624	7,245	446.1	7.3	1,624	7,245	446.1	7.3
Puttalam	789	2,837	359.6	3.5	760	2,647	348.3	2.5	769	3,163	411.3	3.2	769	3,163	411.3	3.2
Anuradhapura	840	4,507	536.5	5.5	861	7,355	854.2	7.0	868	5,950	685.5	6.0	868	5,950	685.5	6.0
Polonnaruwa	415	1,743	420.0	2.1	406	2,049	504.7	1.9	408	1,836	450.0	1.8	408	1,836	450.0	1.8
Badulla	897	1,992	222.1	2.4	815	1,620	198.8	1.5	822	1,889	229.8	1.9	822	1,889	229.8	1.9
Monaragala	445	1,771	398.0	2.2	449	2,231	496.9	2.0	456	2,331	511.2	2.3	456	2,331	511.2	2.3
Ratnapura	1,139	4,208	369.4	5.1	1,086	5,275	485.7	4.9	1,097	3,422	311.9	3.4	1,097	3,422	311.9	3.4
Kegalle	823	2,385	289.8	2.9	840	2,935	349.4	2.8	844	3,156	373.9	3.2	844	3,156	373.9	3.2
Total	20,869	81,840	392.2	100.0	20,328	107,760	530.1	100.0	20,483	99,639	486.4	100.0	20,483	99,639	486.4	100.0

Source ; Department of Prisons

Table 3.10

**LENGTH OF PERIOD SPENT IN CUSTODY BY ALL
REMANDEES AS ON 31ST DECEMBER 2013**

	Male	Female	Total	Percentage of Total Remandees
Under 14 Days	1,775	101	1,876	18.7
14 Days to 1 Month	2,157	147	2,304	23.0
1 Month to 6 Months	1,993	129	2,122	21.1
6 Months to 1 year	1,424	86	1,510	15.1
1 Year to 1 1/2 Years	827	58	885	8.8
1 1/2 Year to 2 Years	516	37	553	5.5
2 Years to 3 Years	278	24	302	3.0
3 Years to 4 Years	198	15	213	2.1
4 Years to 5 Years	133	7	140	1.4
5 Years and Above	120	7	127	1.3
Under Detention	-	-	-	-
Total	9,421	611	10,032	100

Source ; Department of Prisons

Table 3.11

AVERAGE LENGTH OF TIME SPENT ON REMAND AS ON 31ST DECEMBER OF EACH YEAR, 2009 - 2013

Period	2009	%	2010	%	2011	%	2012	%	2013	%
Under 6 Months	8,622	64.5	8,721	66.1	6,250	63.5	6,231	51.5	5,322	53.1
6 Months to 12 Months	1,663	12.5	1,603	12.1	1,435	14.6	2,599	21.5	2,533	25.2
12 Months to 18 Months	1,031	7.7	844	6.4	748	7.6	1,369	11.3	1,191	11.9
18 Months to 2 Years	739	5.5	685	5.2	568	5.8	961	7.9	578	5.8
Over 2 Year	1,315	9.8	1,343	10.2	834	8.5	938	7.8	408	4.1
Total	13,370	100.0	13,196	100.0	9,835	100.0	12,098	100.0	10,032	100.0

Source ; Department of Prisons

Table 3.12

DAILY AVERAGE OF UNCONVICTED PRISONERS, 2003 - 2013

Year	Male	Female	Total	Mid Year Estimated Population in '000	Proportion of Remandees as a Percentage of Mid Year Estimated Population in '000
2003	10,411	506	10,917	19,252	0.06
2004	10,345	497	10,842	19,462	0.06
2005	10,602	614	11,216	19,668	0.06
2006	10,910	714	11,624	19,886	0.06
2007	11,592	757	12,349	20,010	0.06
2008	11,787	850	12,637	20,217	0.06
2009	13,143	986	14,129	20,450	0.07
2010	13,038	852	13,890	20,653	0.07
2011	10,487	898	11,385	20,869	0.05
2012	11,504	801	12,305	20,328	0.06
2013	11,416	793	12,209	20,483	0.06

Source ; Department of Prisons

Table 3.13

ANNUAL ADMISSIONS OF CONVICTED AND REMAND PRISONERS, 2005 - 2013

Year	Admissions			Ratio			Remandees % Total Inmate Population
	Convicted	Remand	Total	Convicted	Remand	Total	
2005	33,034	96,007	129,041	1	3	4	74.4
2006	28,732	89,190	117,922	1	3	4	75.6
2007	31,306	99,513	130,819	1	3	4	76.1
2008	33,566	102,245	135,811	1	3	4	75.3
2009	37,872	108,868	146,740	1	3	4	74.2
2010	32,128	100,191	132,319	1	3	4	75.7
2011	27,018	81,840	108,858	1	3	4	75.2
2012	28,391	107,760	136,151	1	3	4	79.1
2013	30,760	99,639	130,399	1	3	4	76.4

Source ; Department of Prisons

Table 3.14

DAILY AVERAGE OF CONVICTED AND UNCONVICTED PRISONERS , 2005 - 2013

Year	Daily Average of Convicted	Daily Average of Remandees	Total	Ratio of Daily Average			Percentage of Remandees
				Convicted	Remand	Total	
2005	10,898	11,216	22,114	1	1.0	2.0	50.7
2006	11,243	11,624	22,867	1	1.0	2.0	50.8
2007	11,906	12,349	24,255	1	1.0	2.0	50.9
2008	13,487	12,637	26,124	1	0.9	1.9	48.4
2009	13,694	14,129	27,823	1	1.0	2.0	50.8
2010	13,094	13,890	26,984	1	1.1	2.1	51.5
2011	11,104	11,385	22,489	1	1.0	2.0	50.6
2012	11,298	12,305	23,603	1	1.1	2.1	52.1
2013	9,508	12,209	21,717	1	1.3	2.3	56.2

Source ; Department of Prisons

CONVICTED PRISONERS

CONVICTED PRISONERS, 2009 - 2013

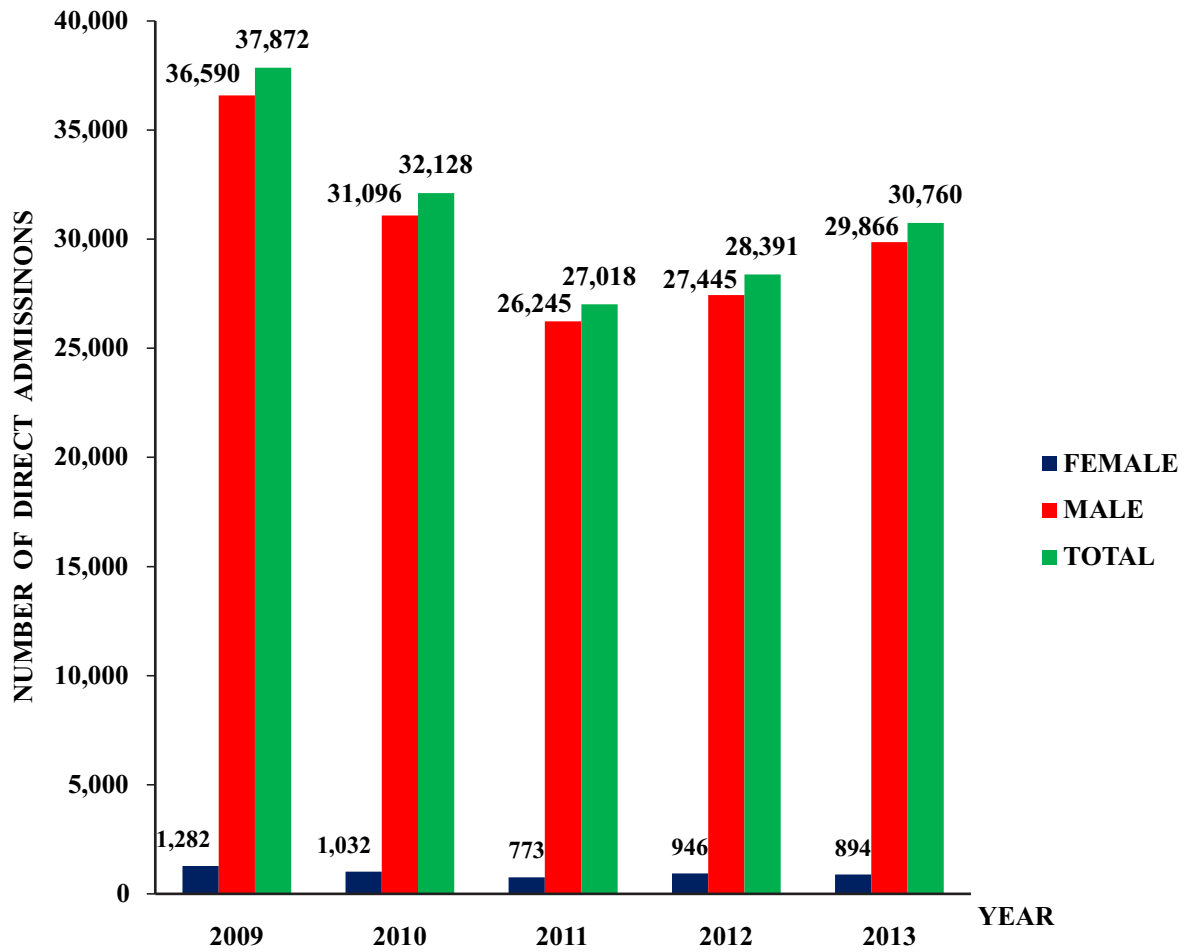

Table 4.1

DIRECT ADMISSIONS OF CONVICTED PRISONERS BY INSTITUTIONS, 2009 - 2013

Institution	2009			2010			2011			2012			2013		
	Male	Female	Total	Male	Female	Total	Male	Female	Total	Male	Female	Total	Male	Female	Total
	Welikada Prison	16,668	636	17,304	13,932	399	14,331	11,716	356	12,072	10,015	489	10,504	11,369	428
Colombo Remand Prison	-	-	-	-	-	-	-	-	-	-	-	-	-	-	-
New Magazine Remand Prison	-	-	-	-	-	-	-	-	-	-	-	-	-	-	-
Mahara Prison	1,811	-	1,811	1,523	-	1,523	1,736	-	1,736	2,528	-	2,528	3,178	-	3,178
Bogambara Prison	2,224	-	2,224	1,860	-	1,860	1,334	-	1,334	1,879	-	1,879	1,700	-	1,700
Kandy Remand Prison	-	52	52	-	51	51	-	52	52	-	69	69	-	50	50
Jaffna Remand Prison	363	79	442	418	55	473	244	19	263	241	8	249	236	17	253
Anuradhapura Remand Prison	2,026	57	2,083	1,572	77	1,649	1,173	17	1,190	1,514	41	1,555	1,390	36	1,426
Badulla Remand Prison	812	8	820	552	17	569	521	12	533	411	6	417	569	2	571
Batticaloa Remand Prison	583	63	646	732	95	827	528	19	547	522	15	537	759	46	805
Galle Remand Prison	1,680	58	1,738	1,669	35	1,704	1,355	33	1,388	1,515	55	1,570	1,402	68	1,470
Matara Remand Prison	606	8	614	375	10	385	301	7	308	351	10	361	371	6	377
Tangalle Remand Prison	373	6	379	331	4	335	305	8	313	385	14	399	455	4	459
Negambo Remand Prison	1,439	74	1,513	1,498	66	1,564	1,287	55	1,342	1,851	48	1,899	2,022	70	2,092
Ambepussa T.S.Y.O.	26	-	26	32	-	32	28	-	28	16	-	16	29	-	29
Trincomalee Remand Prison	717	50	767	447	16	463	292	10	302	311	13	324	347	10	357
Kegalle Remand Prison	1,248	-	1,248	1,280	-	1,280	968	-	968	1,028	-	1,028	991	-	991
Kalutara Remand Prison	2,353	93	2,446	1,681	58	1,739	1,389	44	1,433	1,301	43	1,344	1,692	43	1,735
Kuruwita Remand Prison	1,322	30	1,352	1,026	16	1,042	1,025	31	1,056	1,488	41	1,529	1,120	26	1,146
Polonnaruwa Remand Prison	807	19	826	617	46	663	490	16	506	344	15	359	397	16	413
Monaragala Remand Prison	579	6	585	486	14	500	366	9	375	551	12	563	440	9	449
Boossa Prison	-	-	-	-	-	-	-	-	-	-	-	-	-	-	-
Wariyapola Remand Prison	880	39	919	736	58	794	806	48	854	873	44	917	768	45	813
Vavuniya Remand Prison	73	4	77	329	15	344	381	37	418	321	23	344	631	18	649
Total	36,590	1,282	37,872	31,096	1,032	32,128	26,245	773	27,018	27,445	946	28,391	29,866	894	30,760

Source: Department of Prisons

Note : In 2011 No information was received from the New Magazine Remand Prison as all documents were set on fire and destroyed by the Prisoners riot as reported by the Superintendent of Prisons New Magazine.

Table 4.2

DIRECT ADMISSIONS OF CONVICTED PRISONERS ACCORDING TO AGE GROUPS, 2009 - 2013

Age Group	2009			2010			2011			2012			2013		
	Male	Female	Total	Male	Female	Total	Male	Female	Total	Male	Female	Total	Male	Female	Total
Under 16 Years	11	-	11	5	-	5	102	-	102	19	-	19	-	-	-
16 and under 22 years	1,967	103	2,070	1,921	79	2,000	1,472	66	1,538	1,716	86	1,802	1,669	42	1,711
22 and under 30 years	12,881	395	13,276	7,051	265	7,316	5,556	238	5,794	5,818	269	6,087	6,698	199	6,897
30 and under 40 years	12,951	425	13,376	9,531	326	9,857	8,541	197	8,738	8,410	253	8,663	10,287	308	10,595
40 and under 50 years	5,701	218	5,919	8,354	212	8,566	6,942	156	7,098	7,336	177	7,513	7,561	227	7,788
50 and 60 years	2,089	93	2,182	3,372	107	3,479	2,867	85	2,952	3,407	122	3,529	3,009	101	3,110
60 years and above	990	48	1,038	862	43	905	765	31	796	739	39	778	642	17	659
Total	36,590	1,282	37,872	31,096	1,032	32,128	26,245	773	27,018	27,445	946	28,391	29,866	894	30,760

Source: Department of Prisons

Table 4.3

DIRECT ADMISSIONS OF CONVICTED PRISONERS ACCORDING TO LITERACY, 2009 - 2013

	2009			2010			2011			2012			2013		
	Male	Female	Total	Male	Female	Total	Male	Female	Total	Male	Female	Total	Male	Female	Total
No Schooling	1,908	164	2,072	2,710	135	2,845	1,255	95	1,350	1,814	106	1,920	1,456	82	1,538
Grade 1-5	5,589	460	6,049	4,921	230	5,151	4,414	151	4,565	4,959	448	5,407	5,331	137	5,468
Passed Grade 5	6,216	239	6,455	6,877	188	7,065	5,828	162	5,990	5,742	112	5,854	5,760	201	5,961
Passed Grade 8	7,715	262	7,977	9,203	237	9,440	7,347	207	7,554	7,938	195	8,133	9,037	238	9,275
Passed G.C.E (O/L)	10,999	110	11,109	5,153	183	5,336	3,949	121	4,070	3,768	66	3,834	4,412	161	4,573
Passed G.C.E (A/L)	4,125	43	4,168	1,300	53	1,353	1,156	33	1,189	1,058	15	1,073	1,275	51	1,326
Graduate	24	4	28	40	6	46	37	4	41	29	4	33	36	9	45
Others	14	-	14	892	-	892	2,259	-	2,259	2,137	-	2,137	2,559	15	2,574
Total	36,590	1,282	37,872	31,096	1,032	32,128	26,245	773	27,018	27,445	946	28,391	29,866	894	30,760

Source: Department of Prisons

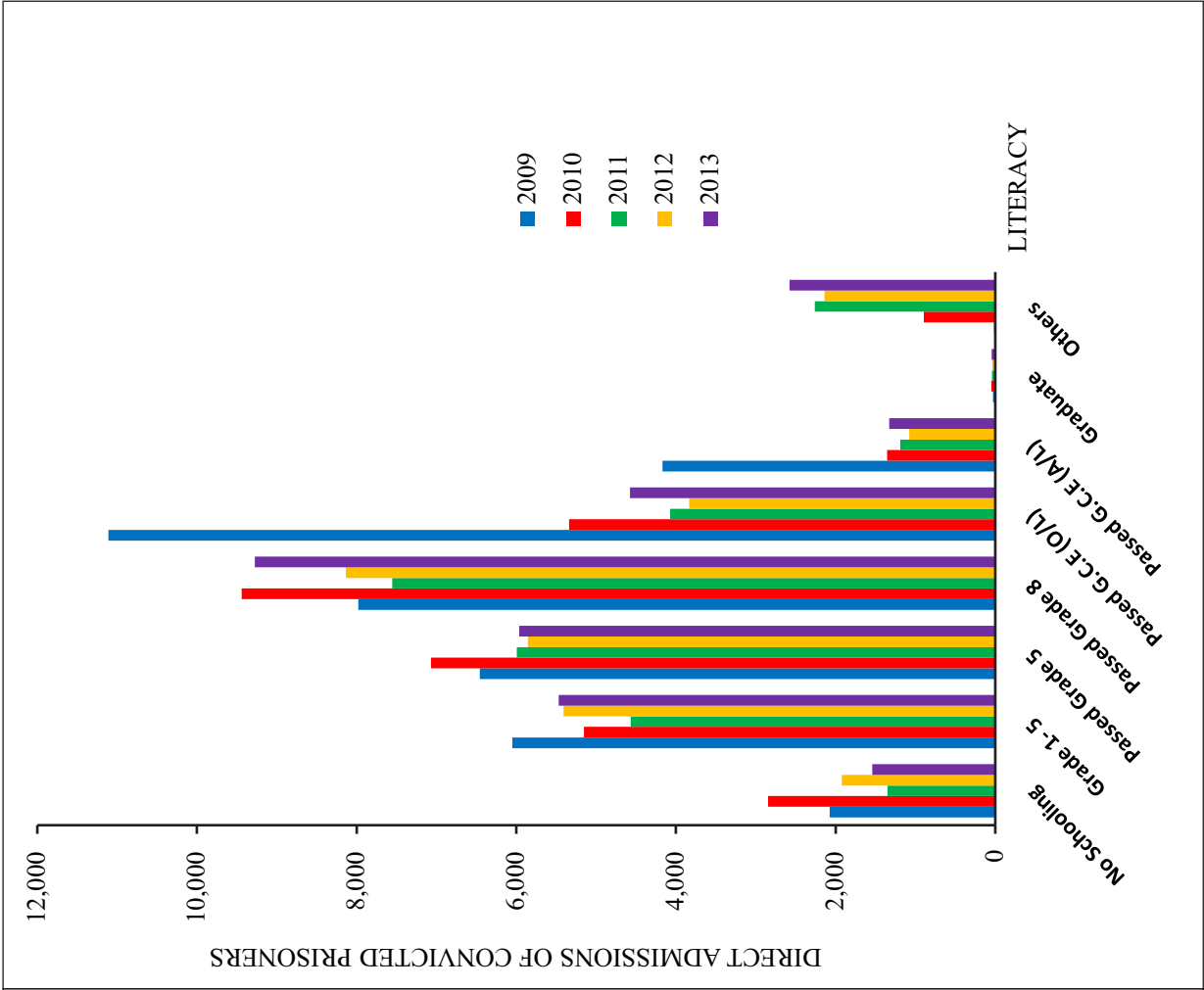
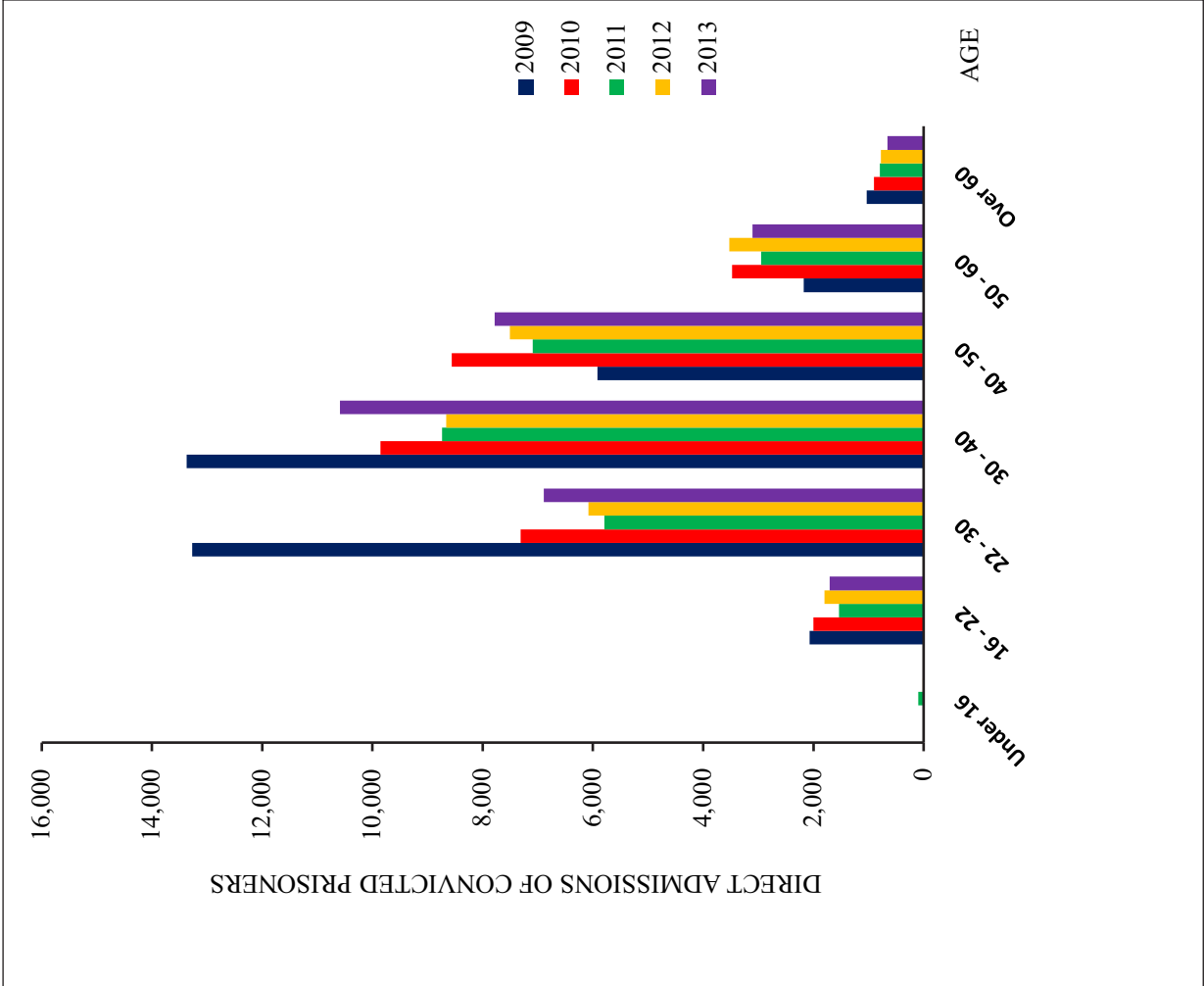

Table 4.4

**DIRECT ADMISSIONS OF CONVICTED PRISONERS BY RACE AND
THE PERCENTAGE DISTRIBUTIONS, 2009 - 2013**

Year	All Races	Race															
		Sinhalese	%	Tamil			Moor			Malay	%	Burgher	%	Others	%		
				Sri Lankan	Indian	%	Sri Lankan	Indian	%								
2009	37,872	27,087	71.5	4,544	12.0	779	2.1	5,120	13.5	198	0.5	58	0.2	71	0.2	15	0.0
2010	32,128	22,664	70.5	4,776	14.9	383	1.2	3,999	12.4	7	0.0	57	0.2	94	0.3	148	0.5
2011	27,018	19,279	71.4	3,460	12.8	704	2.6	3,292	12.2	7	0.0	83	0.3	87	0.3	106	0.4
2012	28,391	20,498	72.2	3,705	13.1	353	1.2	3,613	12.8	5	0.0	58	0.2	63	0.2	96	0.3
2013	30,760	22,244	72.3	4,354	14.2	238	0.8	3,619	11.7	4	0.0	64	0.2	93	0.3	144	0.5

Source: Department of Prisons

Table 4.5

**DIRECT ADMISSIONS OF CONVICTED PRISONERS BY RELIGION AND
THE PERCENTAGE DISTRIBUTIONS, 2009 - 2013**

Year	All Religions	Religion											
		Buddhist	%	Hindu	%	Islam	%	Roman Catholic	%	Other Christians	%	Others	%
2009	37,872	22,916	60.5	5,317	14.0	5,466	14.4	3,271	8.7	868	2.3	34	0.1
2010	32,128	18,228	56.7	6,217	19.4	4,062	12.6	2,164	6.7	1,304	4.1	153	0.5
2011	27,018	17,394	64.4	3,187	11.8	3,366	12.4	1,597	5.9	1,373	5.1	101	0.4
2012	28,391	18,134	63.9	3,446	12.1	3,646	12.9	1,687	5.9	1,396	4.9	82	0.3
2013	30,760	19,891	64.7	3,646	11.9	3,856	12.5	1,883	6.1	1,415	4.6	69	0.2

Source: Department of Prisons

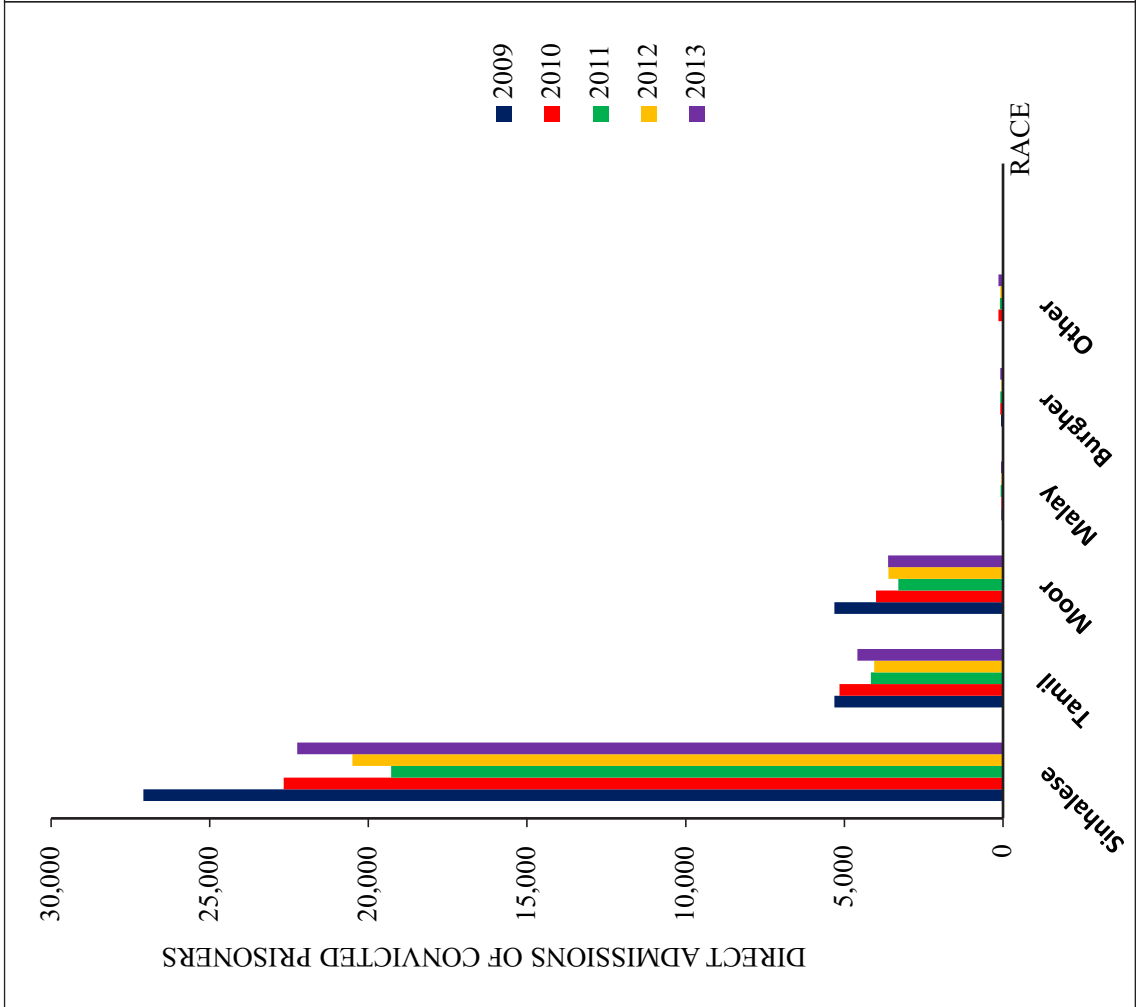
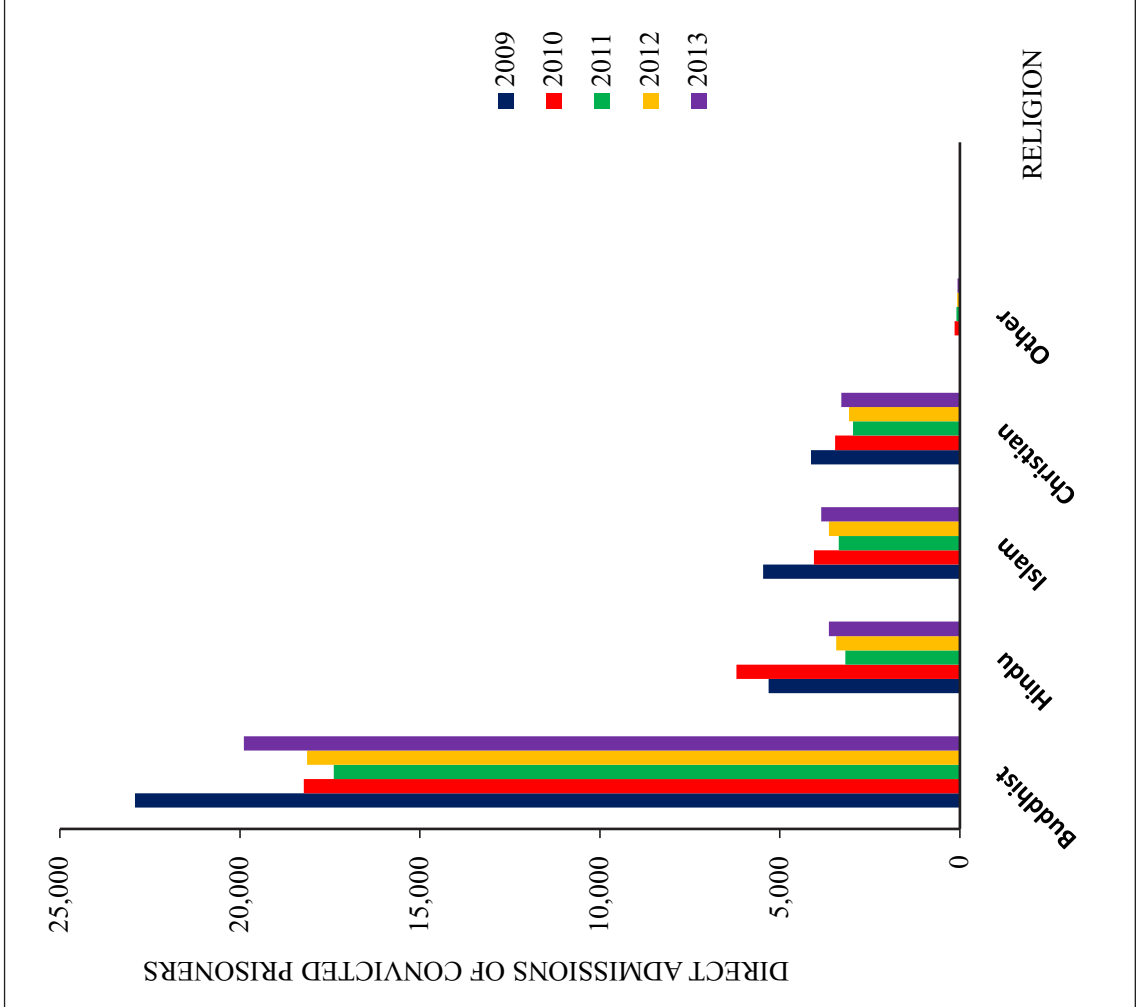

Table 4.6

DIRECT ADMISSIONS OF CONVICTED PRISONERS ACCORDING TO MARITAL STATUS, 2009 - 2013

Marital Status	2009			2010			2011			2012			2013		
	Male	Female	Total	Male	Female	Total	Male	Female	Total	Male	Female	Total	Male	Female	Total
Never Married	6,261	137	6,398	12,301	136	12,437	10,985	122	11,107	9,831	130	9,961	9,869	117	9,986
Married	28,412	985	29,397	17,623	680	18,303	13,947	523	14,470	16,249	713	16,962	18,593	622	19,215
Widowed	351	71	422	261	75	336	299	62	361	446	48	494	349	52	401
Divorced	1,001	56	1,057	632	64	696	586	38	624	408	29	437	622	35	657
Legally Separated	565	33	598	279	77	356	428	28	456	511	26	537	433	68	501
Total	36,590	1,282	37,872	31,096	1,032	32,128	26,245	773	27,018	27,445	946	28,391	29,866	894	30,760

Source: Department of Prisons

Table 4.7
DIRECT ADMISSIONS OF CONVICTED PRISONERS BY DISTRICTS, RATE PER HUNDRED THOUSAND POPULATION AND PERCENTAGE DISTRIBUTION, 2011 - 2013

District	2011				2012				2013			
	Estimated Population in 000's	Number Admitted	Rate per 100000 Population	Percentage Distribution by Districts	Estimated Population in 000's	Number Admitted	Rate per 100000 Population	Percentage Distribution by Districts	Estimated Population in 000's	Number Admitted	Rate per 100000 Population	Percentage Distribution by Districts
Colombo	2,584	10,334	399.9	38.2	2,328	9,178	394.2	32.3	2,326	10,915	469.3	35.5
Gampaha	2,191	3,536	161.4	13.1	2,299	3,895	169.4	13.7	2,313	4,744	205.1	15.4
Kalutara	1,144	1,496	130.8	5.5	1,224	1,248	102.0	4.4	1,227	1,333	108.6	4.3
Kandy	1,447	879	60.7	3.3	1,371	1,370	99.9	4.8	1,384	1,322	95.5	4.3
Matale	504	448	88.9	1.6	482	482	100.0	1.7	489	412	84.3	1.3
Nuwareliya	768	416	54.2	1.5	708	386	54.5	1.4	719	403	56.1	1.3
Galle	1,096	1,541	140.6	5.7	1,063	1,711	161.0	6.0	1,068	1,619	151.6	5.3
Matara	847	421	49.7	1.6	810	484	59.8	1.7	819	497	60.7	1.6
Hambantota	576	369	64.1	1.4	598	377	63.0	1.3	606	352	58.1	1.1
Jaffna	617	284	46.0	1.1	583	264	45.3	0.9	589	271	46.0	0.9
Mannar	105	88	83.8	0.3	99	19	19.2	0.1	101	100	99.0	0.3
Mullativu	144	130	90.3	0.5	92	50	54.3	0.2	93	111	119.4	0.4
Vavuniya	177	137	77.4	0.5	171	384	224.6	1.4	174	447	256.9	1.5
Kilinochchi	160	119	74.4	0.4	114	39	34.2	0.1	116	131	112.9	0.4
Batticaloa	550	350	63.6	1.3	525	337	64.2	1.2	529	512	96.8	1.7
Ampara	654	376	57.5	1.4	648	565	87.2	2.0	658	525	79.8	1.7
Trincomalee	380	296	77.9	1.1	378	305	80.7	1.1	384	338	88.0	1.1
Kurunegala	1,577	1,683	106.7	6.2	1,618	1,989	122.9	7.0	1,624	1,897	116.8	6.2
Puttalam	789	508	64.4	1.9	760	1,000	131.6	3.5	769	995	129.4	3.2
Anuradhapura	840	1,068	127.1	4.0	861	1,300	151.0	4.6	868	972	112.0	3.2
Polonnaruwa	415	352	84.8	1.3	406	275	67.7	1.0	408	455	111.5	1.5
Badulla	897	488	54.4	1.8	815	331	40.6	1.2	822	466	56.7	1.5
Moneragala	445	222	49.9	0.8	449	300	66.8	1.1	456	427	93.6	1.4
Ratnapura	1,139	921	80.9	3.4	1,086	1,326	122.1	4.7	1,097	855	77.9	2.8
Kegalle	823	556	67.6	2.1	840	776	92.4	2.7	844	661	78.3	2.1
Total	20,869	27,018	129.5	100.0	20,328	28,391	139.7	100.0	20,483	30,760	150.2	100.0

Source: Department of Prisons

Table 4.8

NUMBER OF CONVICTED PRISONERS ACCORDING TO PREVIOUS CONVICTIONS, 2010 - 2013

	2010			2011			2012			2013		
	Male	Female	Total	Male	Female	Total	Male	Female	Total	Male	Female	Total
Not convicted before	18,940	591	19,531	10,860	378	11,238	12,056	472	12,528	14,028	418	14,446
Convicted once before	7,371	225	7,596	9,722	190	9,912	8,163	188	8,351	8,979	225	9,204
Convicted twice before	2,701	105	2,806	3,585	68	3,653	3,816	119	3,935	3,858	135	3,993
Convicted thrice before	1,227	50	1,277	1,318	53	1,371	1,900	72	1,972	2,104	70	2,174
Convicted 4 to 6 times	626	22	648	595	31	626	1,299	38	1,337	594	31	625
Convicted 7 to 10 times	171	13	184	110	32	142	153	36	189	188	12	200
Convicted 11 times & over	60	26	86	55	21	76	58	21	79	115	3	118
Total	31,096	1,032	32,128	26,245	773	27,018	27,445	946	28,391	29,866	894	30,760
				100.0		100.0			100.0			100.0

Source: Department of Prisons

Table 4.9

DIRECT ADMISSIONS TO PRISONS & TRAINING SCHOOLS

(Rate of Admissions of Convicted & Unconvicted Prisoners) 2007 - 2013

Year	Estimated Population (Sri Lanka) in ' 000	Convicted Prisoners	Unconvicted Prisoners	Total Admissions	Rate of Admissions per 100,000 of Population		Daily Average Population		Offenders Placed on Probation
					Convicted	Unconvicted	Convicted	Unconvicted	
2007	20,010	31,306	99,513	130,819	156.5	497.3	11,906	12,349	797
2008	20,217	33,566	102,245	135,811	166.0	505.7	13,487	12,637	839
2009	20,450	37,872	108,868	146,740	185.2	532.4	13,694	14,129	1,034
2010	20,653	32,128	100,191	132,319	155.6	485.1	13,094	13,890	855
2011	20,869	27,018	81,840	108,858	129.5	392.2	11,104	11,385	909
2012	20,328	28,391	107,760	136,151	139.7	530.1	11,298	12,305	656
2013	20,483	30,760	99,639	130,399	150.2	486.4	9,508	12,209	*820

Source: Registrar General's Office, Dept. of Probation and Child Care Services, and Department of Prisons

* Provisional

Table 4.10

DIRECT ADMISSIONS OF CONVICTED PRISONERS BY INSTITUTIONS DURING THE YEARS (2011-2012) AND (2012-2013) AND THE NUMERICAL AND PERCENTAGE INCREASE / DECREASE

Institution	Direct Admission of Convicted Prisoners		Numerical increase/decrease in Admissions	Percentage increase/decrease in Admissions	Direct Admission of Convicted Prisoners		Numerical increase/decrease in Admissions	Percentage increase/decrease in Admissions
	2011				2012			
	2011	2012			2012	2013		
Total Admissions	27,018	28,391	1,373	+5.1	28,391	30,760	+2,369	+8.3
Welikada prison	12,072	10,504	-1,568	-13.0	10,504	11,797	+1,293	+12.3
Bogambara prison	1,334	1,879	545	+40.9	1,879	1,700	-179	-9.5
Kandy Remand prison	52	69	17	+32.7	69	50	-19	-27.5
Jaffna Remand prison	263	249	-14	-5.3	249	253	+4	+1.6
Anuradhapura Remand prison	1,190	1,555	365	+30.7	1,555	1,426	-129	-8.3
Badulla Remand prison	533	417	-116	-21.8	417	571	+154	+36.9
Batticaloa Remand prison	547	537	-10	-1.8	537	805	+268	+49.9
Galle Remand prison	1,388	1,570	182	+13.1	1,570	1,470	-100	-6.4
Matara Remand prison	308	361	53	+17.2	361	377	+16	+4.4
Tangalle Remand prison	313	399	86	+27.5	399	459	+60	+15.0
Negombo Remand prison	1,342	1,899	557	+41.5	1,899	2,092	+193	+10.2
Ambepussa T.S.Y.O.	28	16	-12	-42.9	16	29	+13	+81.3
Trincomalee Remand prison	302	324	22	+7.3	324	357	+33	+10.2
Kegalle Remand prison	968	1,028	60	+6.2	1,028	991	-37	-3.6
Kalutara Remand prison	1,433	1,344	-89	-6.2	1,344	1,735	+391	+29.1
Kuruwita Remand prison	1,056	1,529	473	+44.8	1,529	1,146	-383	-25.0
Polonnaruwa Remand prison	506	359	-147	-29.1	359	413	+54	+15.0
Monaragala Remand prison	375	563	188	+50.1	563	449	-114	-20.2
Boossa prison	-	-	-	-	-	-	-	-
New Magazine Remand prison	-	-	-	-	-	-	-	-
Mahara prison	1,736	2,528	792	+45.6	2,528	3,178	+650	+25.7
Wariyapola Remand prison	854	917	63	+7.4	917	813	-104	-11.3
Vavuniya Remand prison	418	344	-74	-17.7	344	649	+305	+88.7

Source: Department of Prisons

Table 4.11

DIRECT ADMISSIONS OF CONVICTED PRISONERS BY CATEGORIES OF OFFENCES, 2009 - 2013

Offence	2009		2010		2011		2012		2013	
	%	%	%	%	%	%	%	%	%	%
Criminal Offences Against Persons	4,666	12.3	2,868	8.9	1,599	5.9	1,977	7.0	2,110	6.9
Offences Against Property	5,771	15.2	5,693	17.7	4,749	17.6	5,961	21.0	7,544	24.5
Offences Against Public Tranquility State Law and Order	2,791	7.4	2,292	7.1	2,236	8.3	3,188	11.2	3,579	11.6
Child abuse	168	0.5	273	0.9	76	0.3	115	0.4	581	1.9
Other Offences	24,476	64.6	21,002	65.4	18,358	67.9	17,150	60.4	16,946	55.1
Total	37,872	100.0	32,128	100.0	27,018	100.0	28,391	100.0	30,760	100.0

Source: Department of Prisons

Table 4.12

**DIRECT ADMISSIONS OF CONVICTED PRISONERS BY TYPE OF OFFENCES
AND RATE PER 100,000 OF POPULATION, 2007 - 2013**

Type of Offences	Year						
	2007	2008	2009	2010	2011	2012	2013
" A " Criminal offences Against Persons							
1. Murder (Sentenced to Death)	167	124	108	96	103	125	118
2. Attempted Murder	144	166	121	149	113	144	115
3. Culpable Homicide	299	462	130	172	143	163	130
4. Attempted Culpable Homicide	96	67	84	149	67	110	98
5. Kidnapping	12	2	11	87	6	11	14
6. Rape							
* Rape of Persons in One's Custody taking advantage of one's official position	2	5	2	3	-	2	-
* Rape of a pregnant Woman	-	-	2	1	1	-	-
* Rape of a Woman over 18 years of age	109	121	142	131	100	166	141
* Rape of a Woman less than 18 years of age	99	113	72	83	53	62	68
* Rape of a mentally or physically Handicapped Woman	10	13	4	7	3	8	18
* Gang Rape	15	67	5	25	9	35	17
7. Grievous Hurt	149	114	138	169	96	110	136
8. Simple Hurt	118	176	179	178	121	174	171
9. Bigamy	34	24	26	71	33	16	32
10. Unnatural Offences	45	20	58	25	11	10	14
11. Concealment of Birth	2	12	3	5	3	1	22
12. Criminal Force	54	45	25	31	12	11	13
13. Criminal Intimidation	10	1	6	54	6	6	8
14. Unlawful Intercourse and Attempt	24	65	163	208	142	195	33
15. Abortion and attempt to abort	-	9	3	4	6	7	35
16. Attempt Suicide and abetment of Suicide	14	2	-	-	-	3	3
17. Causing Death by Reckless Driving	64	87	40	73	30	52	73
18. Causing Grievous Injury by Reckless Driving	88	127	105	228	122	185	206
19. Sexual Harassment	75	123	108	265	134	141	142
20. Acts of Gross Indecency	6	11	20	4	5	8	2
21. Sale of Person (Women or Men)	10	9	24	60	11	15	-
22. Punishments meted out by Court Martial	928	2,814	3,020	529	232	206	480
23. Other Offences Against Persons	97	35	67	61	37	11	21
" A " Total	2,671	4,814	4,666	2,868	1,599	1,977	2,110
Estimated Mid - year Population in 000's	20,010	20,217	20,450	20,653	20,869	20,328	20,483
Rate of Admission per 100,000 of Population	13.3	23.8	22.8	13.9	7.7	9.7	10.3

Note: Previously under the number of murder offence is added to the culpable homicide since 2002.

Source: Department of Prisons

Type of Offences	Year						
	2007	2008	2009	2010	2011	2012	2013
" B " Offences Against Property							
1. Burglary	668	524	667	886	497	760	942
2. Robbery	280	370	463	552	322	337	594
3. Trespass / House breaking	447	317	656	402	394	517	516
4. Possession of House breaking Tools	168	233	212	100	94	119	140
5. Extortion	67	51	33	50	63	47	24
6. Looting	530	532	486	633	474	556	1,041
7. Cattle Theft	134	131	295	126	89	193	175
8. Acceptance or Retention of stolen Property	573	497	605	527	518	646	838
9. Cheating	179	228	206	364	270	316	523
10.Criminal Breach of Trust	142	116	115	129	135	185	362
11.Criminal Misappropriation	124	110	220	127	82	174	301
12.Arson	77	37	63	51	29	40	50
13.Causing Damage	108	87	98	81	83	77	71
14.Mischief	89	48	51	26	108	47	34
15.Found in Buildings	2	5	11	7	14	17	18
16.Theft	1,191	1,216	1,268	1,356	1,282	1,700	1,780
17.Forgery	19	17	140	64	32	86	25
18.Counterfeiting of currency	4	2	30	31	18	7	28
19.Bribery	29	22	69	55	25	16	34
20.Cruelty to animals	74	36	64	20	38	22	23
21.Other Offences against Property	181	137	19	106	182	99	25
" B " Total	5,086	4,716	5,771	5,693	4,749	5,961	7,544
Estimated Mid - year Population in 000's	20,010	20,217	20,450	20,653	20,869	20,328	20,483
Rate of Admission per 100,000 of Population	25.4	23.3	28.2	27.6	22.8	29.3	36.8
" C " Offences Against Public Tranquility State Law and Order							
1. Appearing in Public Places Drunk	1,168	962	1,373	1,119	1,087	1,623	1,957
2. Behaviour in a Disorderly Manner	56	96	168	155	114	185	223
3. Clearing of Crown Land	8	19	39	28	32	28	14
4. Committing Affray	69	133	257	94	68	177	169
5. Entering Port without a permit	21	14	24	11	20	10	8
6. Failure to report to Police	15	18	35	24	19	37	64
7. Giving False evidence	55	72	43	48	82	69	81
8. Lodging in Verandah	235	55	33	49	25	72	25
9. Managing a Brothel	103	62	117	106	116	113	157
10.Possessing Prohibited Knife	108	85	61	34	25	20	36
11.Obstruction of Government Officers	40	77	65	56	54	56	79
12.Profitteering	29	13	8	3	-	5	11
13.Rioting	70	100	83	50	74	102	99
14.Traveling by Train or by Bus without Tickets	1	7	10	8	8	4	14
15.Unlawful Assembly	48	40	28	27	39	45	53
16.Unlawful Betting and Gambling	178	195	193	151	180	185	272
17.Using Explosives to kill fish	11	21	9	31	44	33	52
18.Viewing of Blue Films	14	5	19	17	31	37	66
19.Gemming illegally	136	123	92	59	49	56	47
20.Possessing Guns, Pistols etc. without License	105	80	69	124	67	63	77
21.Non payment of Income Tax	18	1	13	2	7	21	2
22.Other Offences Against Public Tranquility State Law and Order	102	191	52	96	95	247	73
" C " Total	2,590	2,369	2,791	2,292	2,236	3,188	3,579
Estimated Mid - year Population in 000's	20,010	20,217	20,450	20,653	20,869	20,328	20,483
Rate of Admission per 100,000 of Population	12.9	11.7	13.6	11.1	10.7	15.7	17.5

Source: Department of Prisons

Type of Offences	Year						
	2007	2008	2009	2010	2011	2012	2013
" D " Other offences							
1. Excise Offences	7,865	8,568	9,696	5,790	6,174	6,183	4,633
2. Maintenance	825	782	1,011	951	951	1,067	1,069
3. Motor Offences	472	822	390	777	599	551	566
4. Narcotik drugs Offences							
Drugs (Sentenced to Death)	9	4	-	-	4	6	6
Drugs (Other Offences)	11,469	11,061	13,319	13,378	10,564	9,275	10,442
5. Other Offences	245	190	53	2	48	24	170
" D " Total	20,885	21,427	24,469	20,898	18,340	17,106	16,886
Estimated Mid - year Population in 000's	20,010	20,217	20,450	20,653	20,869	20,328	20,483
Rate of Admission per 100,000 of Population	104.4	106.0	119.7	101.2	87.9	84.1	82.4
" E " Offences							
1. Prisoners Punished Under Emergency Regulations	-	2	1	4	5	2	20
2. Prisoners Punished Under The Prevention of Terrorism	-	1	6	100	13	42	40
" E " Total	0	3	7	104	18	44	60
Estimated Mid - year Population in 000's	20,010	20,217	20,450	20,653	20,869	20,328	20,483
Rate of Admission per 100,000 of Population	0.0	0.0	0.0	0.5	0.1	0.2	0.3
Child Abuse							
1. Use of Children for Photographic Publications and Display	3	2	31	14	-	-	36
2. Cruelty to Children	9	3	3	41	9	5	70
3. Sexual Abuse of Children	14	43	57	51	24	40	100
4. Incest	2	39	-	2	1	1	1
5. Inducement and Involvement of Children to Beggar	3	15	5	20	4	8	23
6. Having Sexual Intercourse with Children	5	39	28	35	5	20	77
7. Involvement of Children in Sexual Activities and Procurement of Children for Same	2	17	2	-	6	2	-
8. Use of Children in Drug Trafficking	14	31	2	9	2	5	78
9. Unnatural Offences (With Children Under 16 Years)	3	3	18	21	1	3	53
10. Acts of Gross Indecency (With Children Under 16 Years)	2	7	3	2	-	4	32
11. Procuration	-	14	1	1	-	-	-
12. Sale of Children (Under 18 Years)	3	3	-	2	-	-	8
13. Rape of a Girl (Under 16 Years)	14	21	18	75	24	27	103
Child Abuse Total	74	237	168	273	76	115	581
Estimated Mid - year Population in 000's	20,010	20,217	20,450	20,653	20,869	20,328	20,483
Rate of Admission per 100,000 of Population	0.4	1.2	0.8	1.3	0.4	0.6	2.8
Grand Total	31,306	33,566	37,872	32,128	27,018	28,391	30,760
Estimated Mid - year Population in 000's	20,010	20,217	20,450	20,653	20,869	20,328	20,483
Rate of Admission per 100,000 of Population	156.5	166.0	185.2	155.6	129.5	139.7	150.8

Source : Department of Prisons

Table 4.13

DIRECT ADMISSIONS OF CONVICTED PRISONERS ACCORDING TO NARCOTIC DRUGS & EXCISE OFFENCES, 2009 - 2013

Offence	Year									
	2009	%	2010	%	2011	%	2012	%	2013	%
Narcotic Drug Offences	13,319	35.2	13,378	41.6	10,568	39.1	9,281	32.7	10,448	34.0
Excise Offences	9,696	25.6	5,790	18.0	6,174	22.9	6,183	21.8	4,633	15.0
Other Offences	14,857	39.2	12,960	40.4	10,276	38.0	12,927	45.5	15,679	51.0
Total	37,872	100.0	32,128	100.0	27,018	100.0	28,391	100.0	30,760	100.0

Source: Department of Prisons

Table 4.14

DIRECT ADMISSIONS OF CONVICTED PRISONERS ACCORDING TO SELECTED OFFENCES, 2009 - 2013

Offence	Year									
	2009	%	2010	%	2011	%	2012	%	2013	%
Narcotic Drug Offences	13,319	35.2	13,378	41.6	10,568	39.1	9,281	32.7	10,448	34.0
Excise Offences	9,696	25.6	5,790	18.0	6,174	22.9	6,183	21.8	4,633	15.0
Maintenance	1,011	2.7	951	3.0	951	3.5	1,067	3.8	1,069	3.5
Appearing in Public Places Drunk	1,373	3.6	1,119	3.5	1,087	4.0	1,623	5.7	1,957	6.4
Looting	486	1.3	633	2.0	474	1.8	556	2.0	1,041	3.4
Viewing of Blue Films	19	0.1	17	0.1	31	0.1	37	0.1	66	0.2
Simple Hurt	179	0.5	178	0.6	121	0.5	174	0.6	171	0.6
Cheating	206	0.5	364	1.1	270	1.0	316	1.1	523	1.7
Acceptance or Retention of stolen Property	605	1.6	527	1.6	518	1.9	646	2.3	838	2.7
Theft	1,268	3.3	1,356	4.2	1,282	4.7	1,700	6.0	1,780	5.8
Other Offences	9,710	25.6	7,815	24.3	5,542	20.5	6,808	24.0	8,234	26.7
Total	37,872	100.0	32,128	100.0	27,018	100.0	28,391	100.0	30,760	100.0

Source: Department of Prisons

Table 4.15

GRAVE CRIME OFFENCES AGAINST PERSONS, 2007 - 2013

Type of Offences	Year						
	2007	2008	2009	2010	2011	2012	2013
Offences Against Persons							
1. Abduction / Kidnapping	1,229	1,239	947	897	1,012	1,240	1,087
2. Grievous Hurt	1,675	1,367	1,368	1,410	1,719	1,727	1,427
3. Homicide / Abetment to commit Suicide	1,663	1,488	958	745	707	646	586
4. Attempted Homicide	468	397	289	308	229	227	209
5. Hurt by Knife etc.	3,642	3,250	2,920	2,939	2,942	2,870	2,671
6. Rape / Incest	1,398	1,582	1,624	1,854	1,870	2,212	2,181
7. Unnatural Offences / Grave Sexual Abuse	475	457	441	519	517	576	571
8. Offences under the offensive weapons act.	668	529	395	277	147	162	125
9. Procuration / Trafficking	30	33	31	47	56	31	9
10. Cruelty to children and Sexual exploitation of children	366	340	346	334	376	398	440
Total	11,614	10,682	9,319	9,330	9,575	10,089	9,306
Estimated Mid - year Population in 000's	20,010	20,217	20,450	20,653	20,869	20,328	20,483
Rate of Admission per 100,000 of Population	58.0	52.8	45.6	45.2	45.9	49.6	45.4

Source: Police Department

Table 4.16

GRAVE CRIME OFFENCES AGAINST PROPERTY, 2007 - 2013

Type of Offences	Year						
	2007	2008	2009	2010	2011	2012	2013
Offences Against Property							
1. Arson	721	601	585	691	576	585	447
2. Mischief over Rs.5000/=	1,272	1,253	1,096	1,323	1,069	1,096	1,028
3. Theft of Property including Praedial Produce over Rs.5000/= & cycle and Cattle Thefts irrespective of their value	12,674	13,367	11,973	12,680	11,962	11,704	11,449
4. Riots	17	10	14	14	25	18	6
5. Robbery	7,139	6,754	6,163	6,521	6,304	6,552	4,743
6. Cheating / Misappropriation C.B.Trust over Rs.100000/=	3,587	9,059	9,198	7,238	6,365	8,820	10,419
7. Extortion	140	127	150	103	125	138	138
8. Offences against the State	8	9	21	15	8	5	1
9. Counterfitting Currency	37	34	52	38	47	45	59
10. Possession of automatic or repeater shot guns	39	51	91	80	52	32	33
11. Manufacture or any Quantity Heroin, Cocaine, Morphine, Trafficking import or possession of danger Drugs of an above 2gms of Heroin	572	511	636	862	1,067	1,315	1,604
12. House breaking & Theft	18,635	18,412	18,042	18,665	17,192	16,763	16,116
Total	44,841	50,188	48,021	48,230	44,792	47,073	46,043
Estimated Mid - year Population in 000's	20,010	20,217	20,450	20,653	20,869	20,328	20,483
Rate of Admission per 100,000 of Population	224.1	248.2	234.8	233.5	214.6	231.5	224.8

Note: (1). The Offence No.3 includes following offences only prior to 2001.

Cattle Theft, Theft of Bicycles & Theft of Property over Rs.100/=

(11). The Offence No.6 includes over Rs.1000/=, prior to 2001.

(111). The Offence No.11 includes 2gms of Cocaine, 3gms of Morphine, 500gms of Opium, 5kgs of Cannabis and 1kg of Hashish, for the year 2002 and onwards.

Source: Police Department

Table 4.17

DIRECT ADMISSIONS OF TRAINING SCHOOL INMATES PRISONERS SENTENCED TO DEATH AND OTHER CONVICTED PRISONERS ACCORDING TO AGE, 2011 - 2013

Age Group	Year											
	2011				2012				2013			
	Training School	Condemned Prisoners	Other Convicted Prisoners	Total	Training School	Condemned Prisoners	Other Convicted Prisoners	Total	Training School	Condemned Prisoners	Other Convicted Prisoners	Total
Under 16 Years	-	-	102	102	-	-	19	19	-	-	-	-
16 and under 22 years	28	-	1,510	1,538	16	-	1,786	1,802	29	-	1,682	1,711
22 and under 30 years	-	13	5,781	5,794	-	12	6,075	6,087	-	10	6,887	6,897
30 and under 40 years	-	16	8,722	8,738	-	31	8,632	8,663	-	27	10,564	10,595
40 and under 50 years	-	43	7,055	7,098	-	50	7,463	7,513	-	48	7,740	7,788
50 and 60 years	-	28	2,924	2,952	-	31	3,498	3,529	-	33	3,077	3,110
60 years and above	-	7	789	796	-	7	771	778	-	6	653	659
Total	28	107	26,883	27,018	16	131	28,244	28,391	29	124	30,607	30,760

Source: Department of Prisons

Table 4.18

DIRECT ADMISSIONS OF CONVICTED PRISONERS ACCORDING TO COURTS, 2009 - 2013

Name of the Court	Year									
	2009		2010		2011		2012		2013	
		%		%		%		%		%
High Courts	1,488	3.9	1,928	6.0	1,197	4.4	1,746	6.1	1,312	4.3
District Courts	110	0.3	56	0.2	29	0.1	125	0.4	84	0.3
Magistrate Courts	33,184	87.6	29,547	92.0	25,316	93.7	25,631	90.4	28,579	92.9
Other Courts	3,090	8.2	597	1.8	476	1.8	889	3.1	785	2.6
Total	37,872	100.0	32,128	100.0	27,018	100.0	28,391	100	30,760	100

Source: Department of Prisons

Table 4.19

DIRECT ADMISSIONS OF CONVICTED AND UNCONVICTED FOREIGN PRISONERS BY COUNTRY,SEX AND TYPE OF OFFENCES, 2012 - 2013

Name of Country	2012												2013											
	Convicted						Unconvicted						Convicted						Unconvicted					
	Sex			Offences			Sex			Offences			Sex			Offences			Sex					
	Male	Female	Total	Narcotic Drug	Rape	Unlawful Intercourse and Attempt	Cheating	Offences against state Law and Order	Others	Male	Female	Total	Narcotic Drug	Rape	Unlawful Intercourse and Attempt	Cheating	Offences against state Law and Order	Others	Male	Female	Total			
U.S.A.	-	-	-	-	-	-	-	-	-	-	-	-	-	-	-	-	-	-	-	-	-	-		
Germany	1	-	1	1	-	-	-	-	2	-	2	-	-	-	-	-	-	-	-	-	-	-		
England	-	-	-	-	-	-	-	-	4	-	4	-	-	-	-	-	-	-	-	-	-	-		
India	79	-	79	30	-	-	49	-	49	1	50	-	-	-	-	-	-	-	504	6	510	-		
Pakistan	18	1	19	19	-	-	-	-	6	6	10	10	-	-	-	-	-	-	11	-	11	-		
Russia	-	-	-	-	-	-	-	-	5	-	5	-	-	-	-	-	-	-	5	1	6	-		
Australia	-	-	-	-	-	-	-	-	-	-	-	-	-	-	-	-	-	-	2	-	2	-		
Italy	-	-	-	-	-	-	-	-	1	-	1	-	-	-	-	-	-	-	1	-	1	-		
Switzerland	-	-	-	-	-	-	-	-	-	-	-	-	-	-	-	-	-	-	-	-	-	-		
Nigeria	-	-	-	-	-	-	-	-	15	-	15	-	-	-	-	-	-	-	9	-	9	-		
China	3	-	3	-	-	-	3	-	14	36	50	1	-	-	3	3	-	-	11	5	16	-		
Philippines	-	-	-	-	-	-	-	-	1	1	2	-	-	-	-	-	-	-	-	-	-	-		
Japan	-	-	-	-	-	-	-	-	1	-	1	-	-	-	-	-	-	-	1	-	1	-		
Canada	-	-	-	-	-	-	-	-	-	-	-	-	-	-	-	-	-	-	-	-	-	-		
Thailand	-	-	-	-	-	-	-	-	-	3	3	-	-	-	-	-	-	-	-	-	-	-		
Singapore	-	-	-	-	-	-	-	-	1	-	1	-	-	-	-	-	-	-	1	-	1	-		
France	-	-	-	-	-	-	-	-	-	-	-	-	-	-	-	-	-	-	-	-	-	-		
Iraq	-	-	-	-	-	-	-	-	-	-	-	-	-	-	-	-	-	-	-	-	-	-		
Netherlands	-	-	-	-	-	-	-	-	-	-	-	-	-	-	-	-	-	-	-	-	-	-		
Israel	-	-	-	-	-	-	-	-	-	-	-	-	-	-	-	-	-	-	-	-	-	-		
Holland	-	-	-	-	-	-	-	-	-	-	-	-	-	-	-	-	-	-	-	-	-	-		
Cameroon	-	-	-	-	-	-	-	-	4	-	4	-	-	-	-	-	-	-	1	-	1	-		
Ghana	-	-	-	-	-	-	-	-	1	-	1	-	-	-	-	-	-	-	-	-	-	-		
Liberia	-	-	-	-	-	-	-	-	-	-	-	-	-	-	-	-	-	-	-	-	-	-		
Nepal	1	-	1	1	-	-	-	-	1	-	1	-	-	-	-	-	-	-	1	-	1	-		
Malaysia	-	-	-	-	-	-	-	-	-	-	-	-	-	-	-	-	-	-	-	-	-	-		
Belgium	-	-	-	-	-	-	-	-	-	-	-	-	-	-	-	-	-	-	-	-	-	-		
Austria	-	-	-	-	-	-	-	-	-	-	-	-	-	-	-	-	-	-	-	-	-	-		
Sudan	-	-	-	-	-	-	-	-	-	-	-	-	-	-	-	-	-	-	-	-	-	-		
Brazil	-	-	-	-	-	-	-	-	-	-	-	-	-	-	-	-	-	-	-	-	-	-		
Jordan	-	-	-	-	-	-	-	-	2	-	2	-	-	-	-	-	-	-	-	-	-	-		
Sweden	1	-	1	1	-	-	-	-	1	-	1	-	-	-	-	-	-	-	-	-	-	-		
Indonesia	-	-	-	-	-	-	-	-	-	-	-	-	-	-	-	-	-	-	-	-	-	-		
Finland	-	-	-	-	-	-	-	-	-	-	-	-	-	-	-	-	-	-	-	-	-	-		
Other Countries	5	-	5	5	-	-	-	-	95	3	98	3	-	-	2	1	-	-	158	9	167	-		
Total	108	1	109	57	-	-	52	-	203	44	247	21	11	-	5	4	1	704	21	725	-			

Source: Department of Prisons

Table 4.20

DIRECT ADMISSIONS OF WOMEN PRISONERS (Convicted & Unconvicted) BY INSTITUTIONS, 2007 - 2013

Institution	Year													
	2007		2008		2009		2010		2011		2012		2013	
	Convicted	Unconvicted	Convicted	Unconvicted	Convicted	Unconvicted	Convicted	Unconvicted	Convicted	Unconvicted	Convicted	Unconvicted	Convicted	Unconvicted
Welikada prison	-	-	442	2,680	636	2,819	399	2,011	356	1,818	489	2,072	428	1,941
Kandy Remand prison	143	791	70	939	52	664	51	540	52	525	69	709	50	572
Jaffna Remand prison	28	167	25	203	79	347	55	194	19	169	8	127	17	170
Anuradhapura Remand prison	29	254	61	446	57	496	77	461	17	265	41	473	36	391
Badulla Remand prison	16	178	15	186	8	205	17	246	12	145	6	206	2	155
Batticaloa Remand prison	25	103	19	144	63	150	95	187	19	141	15	168	46	253
Galle Remand prison	33	493	55	405	58	396	35	463	33	537	55	308	68	214
Tangalle Remand prison	11	162	8	196	6	161	4	126	8	95	14	180	4	149
Negombo Remand prison	74	589	107	755	74	711	66	608	55	618	48	694	70	823
Trincomalee Remand prison	30	126	19	154	50	134	16	52	10	106	13	151	10	89
Kuruwita Remand prison	25	214	27	287	30	315	16	277	31	274	41	321	26	208
Polonnaruwa Remand prison	18	123	14	95	19	77	46	235	16	94	15	118	16	107
Monaragala Remand prison	9	90	7	124	6	154	14	144	9	153	12	159	9	111
New Magazine Remand prison	505	2,582	-	-	-	-	-	-	-	-	-	-	-	-
Kalutara Remand prison	68	1,399	131	441	93	496	58	323	44	287	43	352	43	450
Matara Remand prison	-	-	8	20	8	164	10	130	7	157	10	245	6	163
Wariyapola Remand prison	-	-	-	-	39	261	58	425	48	373	44	401	45	350
Vavuniya Remand prison	-	-	-	-	4	24	15	174	37	141	23	80	18	129
Total	1,014	7,271	1,008	7,075	1,282	7,574	1,032	6,596	773	5,898	946	6,764	894	6,275

Source: Department of Prisons

Table 4.21

DIRECT ADMISSIONS OF WOMEN PRISONERS (Convicted & Unconvicted) ACCORDING TO AGE, 2007 - 2013

Age Group	Year													
	2007		2008		2009		2010		2011		2012		2013	
	Convicted	Unconvicted	Convicted	Unconvicted	Convicted	Unconvicted	Convicted	Unconvicted	Convicted	Unconvicted	Convicted	Unconvicted	Convicted	Unconvicted
Under 16 Years	8	435	-	382	-	315	-	315	-	202	-	250	-	-
16 and under 22 years	85	1,093	63	881	103	976	79	854	66	721	86	822	42	784
22 and under 30 years	280	1,811	269	1,946	395	1,887	265	1,786	238	1,681	269	1,679	199	1,464
30 and under 40 years	325	1,848	360	2,137	425	2,528	326	1,830	197	1,556	253	1,800	308	1,882
40 and under 50 years	193	1,168	219	1,121	218	1,159	212	1,081	156	938	177	1,274	227	1,243
50 and 60 years	93	592	69	430	93	495	107	523	85	628	122	720	101	699
60 years and above	30	324	28	178	48	214	43	207	31	172	39	219	17	203
Total	1,014	7,271	1,008	7,075	1,282	7,574	1,032	6,596	773	5,898	946	6,764	894	6,275

Source: Department of Prisons

Table 4.22

**DIRECT ADMISSIONS OF CONVICTED WOMEN PRISONERS ACCORDING TO
SELECTED OFFENCES, 2007 - 2013**

Type of Offences	Year						
	2007	2008	2009	2010	2011	2012	2013
Murder	3	3	4	3	6	5	1
Simple Hurt	5	3	5	21	3	1	9
Unlawful Intercourse and Attempt	11	51	153	169	140	178	12
Abortion and attempt to abort	-	9	3	4	5	6	29
Cheating	8	26	19	40	26	21	41
Criminal Misappropriation	15	24	25	26	16	25	40
Theft	70	72	38	54	37	55	90
Committing Affray	-	3	-	4	4	5	9
Giving False evidence	14	12	9	6	11	4	18
Lodging in Verandah	176	27	33	13	4	19	-
Managing a Brothel	68	37	63	35	27	26	54
Rioting	2	4	3	2	-	-	2
Excise Offences	361	396	551	238	183	171	155
Narcotic Drug Offences	159	149	195	178	152	151	210
Other Offences	122	192	181	239	159	279	224
Total	1,014	1,008	1,282	1,032	773	946	894

Source: Department of Prisons

Table 4.23

THE FIRST OFFENDERS & RECIDIVIST, 2003 - 2013

Year	First Offenders	Re - convicted	Recidivist	Total	Percentage		
					First Offenders	Re - convicted	Recidivist
2003	14,848	6,868	5,965	27,681	53.6	24.8	21.6
2004	13,873	8,196	4,829	26,898	51.6	30.5	17.9
2005	16,626	9,881	6,527	33,034	50.3	29.9	19.8
2006	15,114	8,353	5,265	28,732	52.6	29.1	18.3
2007	14,876	9,670	6,760	31,306	47.5	30.9	21.6
2008	17,362	9,007	7,197	33,566	51.7	26.8	21.5
2009	19,276	8,792	9,804	37,872	50.9	23.2	25.9
2010	19,531	7,596	5,001	32,128	60.8	23.6	15.6
2011	11,238	9,912	5,868	27,018	41.6	36.7	21.7
2012	12,528	8,351	7,512	28,391	44.1	29.4	26.5
2013	14,446	9,204	7,110	30,760	47.0	29.9	23.1

Source: Department of Prisons

Table 4.24

DAILY AVERAGE STRENGTH OF CONVICTED AND UNCONVICTED PRISONERS BY INSTITUTIONS, 2009 - 2013

Institution	Year														
	2009			2010			2011			2012			2013		
	Convicted	Unconvicted	Total	Convicted	Unconvicted	Total	Convicted	Unconvicted	Total	Convicted	Unconvicted	Total	Convicted	Unconvicted	Total
Welikada prison	3,910	1,690	5,600	4,510	1,681	6,191	2,909	1,584	4,493	3,207	1,438	4,645	2,320	1,760	4,080
Colombo Remand prison	102	1,333	1,435	93	1,288	1,381	93	1,137	1,230	96	1,115	1,211	94	868	962
New Magazine Remand prison	181	1,668	1,849	145	1,699	1,844	-	-	-	121	1,598	1,719	78	1,259	1,337
Mahara prison	1,381	783	2,164	1,074	799	1,873	864	759	1,623	1,027	767	1,794	110	1,042	1,152
Bogambara prison	1,321	445	1,766	1,579	700	2,279	1,919	649	2,568	1,812	557	2,369	1,725	567	2,292
Kandy Remand prison	54	336	390	41	376	417	37	335	372	16	326	342	55	282	337
Jaffna Remand prison	104	317	421	59	234	293	40	224	264	39	237	276	56	239	295
Anuradhapura Remand prison	282	847	1,129	237	711	948	189	610	799	198	763	961	183	564	747
Badulla Remand prison	134	328	462	104	297	401	102	299	401	122	286	408	94	272	366
Batticaloa Remand prison	97	298	395	101	350	451	86	273	359	84	242	326	117	232	349
Galle Remand prison	226	605	831	171	744	915	143	717	860	141	704	845	156	800	956
Matara Remand prison	91	580	671	68	429	497	88	381	469	83	342	425	96	313	409
Tangalle Remand prison	88	353	441	89	292	381	94	285	379	102	306	408	84	358	442
Negombo Remand prison	225	1,078	1,303	215	1,050	1,265	110	1,133	1,243	159	819	978	246	1,120	1,366
Ambepussa T.S.Y.O.	69	-	69	67	-	67	70	-	70	63	-	63	57	-	57
Trincomalee Remand prison	100	191	291	83	186	269	65	148	213	53	187	240	59	184	243
Kegalle Remand prison	108	447	555	126	434	560	127	411	538	102	438	540	87	401	488
Kalutara Remand prison	390	1,283	1,673	311	932	1,243	342	810	1,152	292	762	1,054	280	799	1,079
Kuruwita Remand prison	341	599	940	233	600	833	240	596	836	225	589	814	282	511	793
Boossa prison	362	-	362	329	-	329	244	-	244	227	-	227	240	-	240
Pallekelle Open prison Camp	717	34	751	709	-	709	714	-	714	696	-	696	678	-	678
Meethirigala Work Camp	73	-	73	67	-	67	56	-	56	56	-	56	51	-	51
Homagama Work Camp	449	-	449	366	-	366	292	-	292	223	-	223	210	-	210
Weeravila Work Camp	794	-	794	604	-	604	651	-	651	416	-	416	451	-	451
Taldena C.C.Y.O.	531	-	531	428	-	428	359	-	359	346	-	346	347	-	347
Kandewatta	133	-	133	118	-	118	73	-	73	73	-	73	66	-	66
Anuradhapura Work Camp	228	-	228	184	-	184	196	-	196	246	-	246	203	-	203
Pallansena C.C.Y.O.	528	-	528	374	-	374	337	-	337	341	-	341	386	-	386
Polonnaruwa Remand prison	156	178	334	111	175	286	113	151	264	96	146	242	107	128	235
Monaragala Remand prison	128	376	504	115	339	454	137	281	418	192	229	421	156	206	362
Wariyapola Remand Prison	248	317	565	166	292	458	165	345	510	224	326	550	214	264	478
Vavuniya Remand prison	6	43	49	41	282	323	36	257	293	18	128	146	23	40	63
Tunkama Work Camp	137	-	137	161	-	161	154	-	154	125	-	125	134	-	134
Hangilipola Work Camp	-	-	-	15	-	15	59	-	59	77	-	77	63	-	63
Total	13,694	14,129	27,823	13,094	13,890	26,984	11,104	11,385	22,489	11,298	12,305	23,603	9,508	12,209	21,717

Source: Department of Prisons

Table 4.25

LENGTH OF SENTENCES, 2009 - 2013

Length of Sentence	Year											
	2009		2010		2011		2012		2013		Percentage of Total Convicted Prisoners	No. of Convicted Prisoners
	No. of Convicted Prisoners	Percentage of Total Convicted Prisoners	No. of Convicted Prisoners	Percentage of Total Convicted Prisoners	No. of Convicted Prisoners	Percentage of Total Convicted Prisoners	No. of Convicted Prisoners	Percentage of Total Convicted Prisoners	No. of Convicted Prisoners	Percentage of Total Convicted Prisoners		
Under 1 Month	3,034	8.0	2,972	9.3	2,098	7.8	3,826	13.5	2,961	9.6		
1 Month to 3 Months	5,383	14.2	5,044	15.7	5,304	19.6	6,091	21.5	6,786	22.1		
3 Months - 6 Months	7,590	20.0	6,106	19.0	5,843	21.6	7,101	25.0	8,227	26.7		
6 Months - 1 Year	8,566	22.6	6,424	20.0	5,706	21.1	4,984	17.6	6,003	19.5		
1 Year - 1 1/2 Years	7,151	18.9	5,372	16.7	3,579	13.3	2,377	8.4	2,586	8.4		
1 1/2 Years - 2 Years	2,224	5.9	2,995	9.3	2,178	8.1	1,395	4.9	1,518	5.0		
2 Years - 3 Years	1,514	4.0	1,254	3.9	888	3.3	1,061	3.7	1,005	3.3		
3 Years - 5 Years	1,591	4.2	1,179	3.7	810	3.0	942	3.3	1,019	3.3		
5 Years - 10 Years	453	1.2	415	1.3	357	1.3	296	1.0	352	1.1		
Over 10 Years	366	1.0	367	1.1	255	0.9	318	1.1	303	1.0		
Total	37,872	100.0	32,128	100.0	27,018	100.0	28,391	100.0	30,760	100.0		

Source: Department of Prisons

Table 4.26

DISCHARGE OF CONVICTED PRISONERS, 2011 - 2013

Basis of Discharge	Year												
	2011		2012		2013		Male	Female	Total	Male	Female	Total	%
	Male	Female	Male	Female	Male	Female							
On punishment	16,481	323	16,804	58.4	18,657	489	19,146	64.0	19,018	413	19,431	61.0	
On bail	265	37	302	1.1	274	31	305	1.0	214	27	241	0.8	
On payment of fines	7,648	296	7,944	27.6	8,747	318	9,065	30.3	9,612	338	9,950	31.2	
On special occasions	3,597	100	3,697	12.9	1,375	40	1,415	4.7	2,169	47	2,216	7.0	
Total	27,991	756	28,747	100.0	29,053	878	29,931	100	31,013	825	31,838	100	

Source: Department of Prisons

YOUTHFUL OFFENDERS

YOUTHFUL OFFENDERS, 2009 - 2013

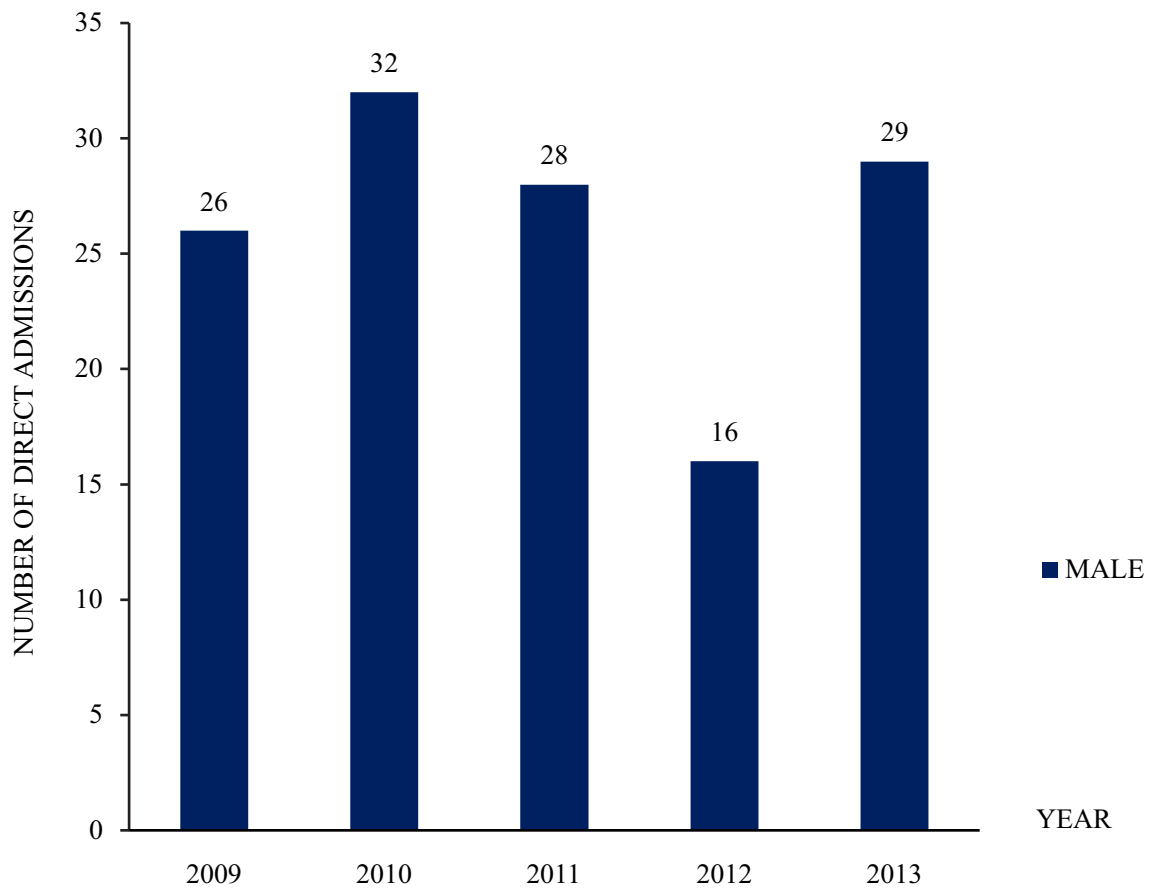

Table 5.1

DIRECT ADMISSIONS AND DAILY AVERAGE POPULATION AT THE TRAINING SCHOOL FOR YOUTHFUL OFFENDERS, WATHUPITIWALA AND THE SCHOOL WAS SHIFTED TO PALLANSENA IN 1997 AND AMBEPUSSA IN 2009.

2004 - 2013

Year	Admissions	Daily Average Population
2004	42	178
2005	55	177
2006	32	125
2007	22	90
2008	36	75
2009	26	69
2010	32	67
2011	28	70
2012	16	63
2013	29	57

Source: Department of Prisons

Table 5.2

DIRECT ADMISSIONS TO TRAINING SCHOOL FOR YOUTHFUL OFFENDERS, AMBEPUSSA, ACCORDING TO AGE GROUPS, 2009 - 2013

Age Group	Year				
	2009	2010	2011	2012	2013
16 & Under 17 Years	20	8	12	5	8
17 & Under 18 Years	2	13	12	6	18
18 & Under 19 Years	2	4	3	5	2
19 & Under 20 Years	-	5	-	-	1
20 & Under 21 Years	-	-	1	-	-
21 & Under 22 Years	2	2	-	-	-
22 Years & Over	-	-	-	-	-
Total	26	32	28	16	29

Source: Department of Prisons

Table 5.3

DIRECT ADMISSIONS TO TRAINING SCHOOL FOR YOUTHFUL OFFENDERS, AMBEPUSSA, ACCORDING TO RESIDENCE, 2009 - 2013

Sector	Year				
	2009	2010	2011	2012	2013
Urban	7	11	9	6	5
Rural	19	21	19	10	24
Total	26	32	28	16	29

Source: Department of Prisons

Table 5.4**DIRECT ADMISSIONS TO TRAINING SCHOOL FOR YOUTHFUL OFFENDERS, AMBEPUSSA,
ACCORDING TO MARITAL STATUS OF DELINQUENT'S FAMILY, 2009 - 2013**

Marital Status of Delinquent's Family	Year				
	2009	2010	2011	2012	2013
Married	1	-	26	16	29
Unmarried	25	32	-	-	-
Separated or Divorced	-	-	2	-	-
Total	26	32	28	16	29

Source: Department of Prisons

Table 5.5**DIRECT ADMISSIONS TO TRAINING SCHOOL FOR YOUTHFUL OFFENDERS, AMBEPUSSA,
ACCORDING TO UP-BRINGING, 2009 - 2013**

Up - Bringing	Year				
	2009	2010	2011	2012	2013
Parents	15	32	24	15	23
Brothers & Sisters	4	-	1	-	2
Foster Parents	2	-	-	-	-
Other Relations & Friends	5	-	1	-	3
Employers	-	-	-	1	1
No Fixed abode	-	-	2	-	-
Not specified	-	-	-	-	-
Total	26	32	28	16	29

Source: Department of Prisons

Table 5.6**DIRECT ADMISSIONS TO TRAINING SCHOOL FOR YOUTHFUL OFFENDERS, AMBEPUSSA,
ACCORDING TO FAMILY PARTICULARS, 2009 - 2013**

Family Particulars	Year				
	2009	2010	2011	2012	2013
Parents Alive	16	20	20	8	19
Farther Dead	5	11	4	4	8
Mother Dead	5	-	1	3	-
Both Dead	-	1	3	1	2
Total	26	32	28	16	29

Source: Department of Prisons

Table 5.7

**DIRECT ADMISSIONS TO TRAINING SCHOOL FOR YOUTHFUL OFFENDERS, AMBEPUSSA,
ACCORDING TO POSITION OF DELINQUENT, 2009 - 2013**

Position	Year				
	2009	2010	2011	2012	2013
Only Child	5	5	5	5	2
Eldest	6	9	1	3	5
Intermediate	9	11	12	6	15
Youngest	6	7	10	2	7
Total	26	32	28	16	29

Source: Department of Prisons

Table 5.8

**DIRECT ADMISSIONS TO TRAINING SCHOOL FOR YOUTHFUL OFFENDERS, AMBEPUSSA,
ACCORDING TO MENTAL DISPOSITION, 2009 - 2013**

Mental Disposition	Year				
	2009	2010	2011	2012	2013
Normal	26	32	28	15	29
Defective	-	-	-	-	-
Aggressive	-	-	-	1	-
Regressive	-	-	-	-	-
Mutual Sex Tendencies	-	-	-	-	-
Homosexual	-	-	-	-	-
Total	26	32	28	16	29

Source: Department of Prisons

Table 5.9

**DIRECT ADMISSIONS TO TRAINING SCHOOL FOR YOUTHFUL OFFENDERS, AMBEPUSSA,
ACCORDING TO LITERACY, 2009 - 2013**

Literacy	Year				
	2009	2010	2011	2012	2013
No Schooling	-	-	2	2	-
Grade 1-5	3	4	1	3	1
Passed Grade 5	1	5	7	3	5
Passed Grade 8	8	23	18	8	23
Passed G.C.E (O/L)	6	-	-	-	-
Passed G.C.E (A/L)	8	-	-	-	-
Total	26	32	28	16	29

Source: Department of Prisons

DEATH SENTENCES

DEATH SENTENCES , 2009 - 2013

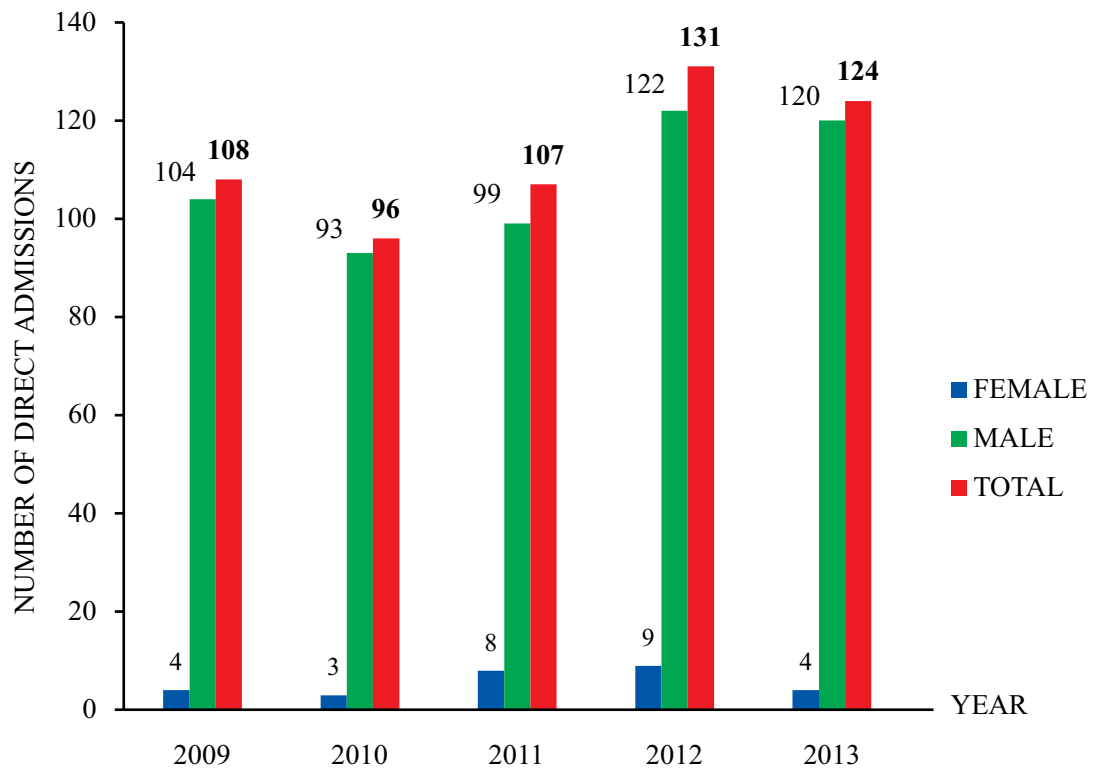

Table 6.1

DEATH SENTENCES, 2003- 2013

Year	Number Sentenced to Death	Number Executed	Number of Death Sentences Committed to Imprisonment	Number under Appeal Awaiting Execution or Final Decision for Commutation of Execution
2003	102	-	-	102
2004	68	-	-	68
2005	113	-	-	113
2006	165	-	-	165
2007	176	-	-	176
2008	128	-	-	128
2009	108	-	-	108
2010	96	-	-	96
2011	107	-	-	107
2012	131	-	-	131
2013	124	-	-	124

Source: Department of Prisons

Table 6.2

**DIRECT ADMISSIONS OF PRISONERS SENTENCED TO DEATH
ACCORDING TO SEX, 2009 - 2013**

Sex	Year				
	2009	2010	2011	2012	2013
Male	104	93	99	122	120
Female	4	3	8	9	4
Total	108	96	107	131	124

Source: Department of Prisons

Table 6.3

**DIRECT ADMISSIONS OF PRISONERS SENTENCED TO DEATH
ACCORDING TO RACE, 2009 - 2013**

Race	Year				
	2009	2010	2011	2012	2013
Sinhalese	88	74	84	99	87
Tamils - Sri Lankan	8	13	14	24	24
Tamils - Indian	-	-	-	-	6
Moors - Sri Lankan	12	9	4	8	7
Moors - Indian	-	-	-	-	-
Malays	-	-	-	-	-
Burghers	-	-	1	-	-
Others	-	-	4	-	-
Total	108	96	107	131	124

Source: Department of Prisons

Table 6.4

**DIRECT ADMISSIONS OF PRISONERS SENTENCED TO DEATH
ACCORDING TO RELIGION, 2009 - 2013**

Religion	Year				
	2009	2010	2011	2012	2013
Buddhist	84	67	78	91	78
Hindu	8	12	14	20	19
Islam	12	9	4	8	11
Roman Catholic	4	8	8	12	13
Others	-	-	3	-	3
Total	108	96	107	131	124

Source: Department of Prisons

Table 6.5

**DIRECT ADMISSIONS OF PRISONERS SENTENCED TO DEATH
ACCORDING TO MARITAL STATUS, 2009 - 2013**

Marital Status	Year				
	2009	2010	2011	2012	2013
Married	90	83	88	108	96
Single	9	13	17	19	22
Divosed, Separated etc.	9	-	2	4	6
Total	108	96	107	131	124

Source: Department of Prisons

Table 6.6

**DIRECT ADMISSIONS OF PRISONERS SENTENCED TO DEATH
ACCORDING TO LITERACY, 2009 - 2013**

Literacy	Year				
	2009	2010	2011	2012	2013
Illiterate	16	2	3	11	7
Literate Up to Grade 8	43	50	46	49	60
Literate above Grade 8	49	44	58	71	57
Total	108	96	107	131	124

Source: Department of Prisons

Table 6.7

**DIRECT ADMISSIONS OF PRISONERS SENTENCED TO DEATH
ACCORDING TO DISTRICTS, 2009 - 2013**

District	Year				
	2009	2010	2011	2012	2013
Colombo	11	5	17	24	10
Gampaha	4	8	5	1	7
Kalutara	1	1	1	10	11
Kandy	2	1	5	-	2
Matale	-	1	1	-	-
Nuwaraeliya	-	1	4	6	10
Galle	15	9	5	5	5
Matara	6	-	1	4	9
Hambantota	3	-	12	13	1
Jaffna	1	2	-	1	1
Mannar	-	-	-	-	-
Vavuniya	-	3	-	-	1
Mullativu	-	-	-	-	-
Batticaloa	3	6	8	13	8
Trincomalee	15	-	-	-	1
Ampara	1	11	-	-	1
Kurunegala	5	-	-	3	5
Puttalam	1	7	7	6	-
Anuradhapura	26	12	7	3	5
Polonnaruwa	-	3	-	2	1
Badulla	1	6	9	3	7
Moneragala	2	-	6	6	20
Ratnapura	11	17	10	9	-
Kegalle	-	3	6	22	19
Kelinochchi	-	-	-	-	-
Other Countries	-	-	3	-	-
Total	108	96	107	131	124

Source: Department of Prisons

Table 6.8

**DIRECT ADMISSIONS OF PRISONERS SENTENCED TO DEATH
ACCORDING TO RESIDENCE, 2009 - 2013**

Sector	Year				
	2009	2010	2011	2012	2013
Urban	25	12	23	76	20
Rural	83	84	84	55	104
Total	108	96	107	131	124

Source: Department of Prisons

Table 6.9

**DIRECT ADMISSIONS OF PRISONERS SENTENCED TO DEATH
ACCORDING TO PREVIOUS PUNISHMENTS, 2009 - 2013**

Punishment	Year				
	2009	2010	2011	2012	2013
None	102	86	82	97	105
Warned & Discharge	1	-	-	-	-
Fined	5	-	-	-	-
Probation	-	-	-	-	-
Certified & Approved School	-	-	-	-	-
Borstal	-	-	-	-	-
Prison	-	10	3	-	11
In Remand Custody Before Conviction	-	-	22	34	8
Other	-	-	-	-	-
Total	108	96	107	131	124

Source: Department of Prisons

Table 6.10

**DIRECT ADMISSIONS OF PRISONERS SENTENCED TO DEATH
ACCORDING TO PREVIOUS CONVICTIONS, 2009 - 2013**

Previous Conviction	Year				
	2009	2010	2011	2012	2013
Not Convicted Before	97	86	102	125	116
Convicted Once Before	7	8	5	6	8
Convicted Twice Before	3	2	-	-	-
Convicted Thrice Before	-	-	-	-	-
Convicted Over Three times Before	1	-	-	-	-
Total	108	96	107	131	124

Source: Department of Prisons

Table 6.11

**DIRECT ADMISSIONS OF PRISONERS SENTENCED TO DEATH
ACCORDING TO INCOME OF OFFENDERS, 2009 - 2013**

Income	Year				
	2009	2010	2011	2012	2013
Rs.250 & Under Rs.300 per Month	48	6	24	32	19
Rs.300 & Over	57	88	72	87	95
No Income	3	2	11	12	10
Total	108	96	107	131	124

Source: Department of Prisons

Table 6.12

**DIRECT ADMISSIONS OF PRISONERS SENTENCED TO DEATH
ACCORDING TO PERSONAL HABITS, 2009 - 2013**

Personal Habit	Year				
	2009	2010	2011	2012	2013
Alcoholism					
Excessively	74	41	52	48	72
Moderately	20	24	30	61	32
Not Addicted	14	31	25	22	20
Total	108	96	107	131	124
Drugs					
Excessively	27	1	2	13	11
Moderately	11	-	-	5	4
Not Addicted	70	95	105	113	109
Total	108	96	107	131	124
Gambling					
Excessively	38	5	22	24	20
Moderately	24	28	33	33	30
Not Addicted	46	63	52	74	74
Total	108	96	107	131	124

Source: Department of Prisons

Table 6.13

**DIRECT ADMISSIONS OF PRISONERS SENTENCED TO DEATH
ACCORDING TO OCCUPATION, 2009 - 2013**

Occupation	Year				
	2009	2010	2011	2012	2013
Cultivators	23	19	39	48	45
Fisherman	1	5	5	6	4
Labour (skilled)	19	6	6	2	5
Labour (Unskilled)	25	15	12	5	11
Tailors	-	1	-	4	2
Carpenters	8	6	2	5	4
Masons	9	6	4	4	5
Craftsmen	-	-	1	-	-
Domestic - Servants	2	-	-	-	-
Waiter	-	-	-	-	-
K.K.S. (Peons)	-	2	3	1	1
Hawkers	-	-	5	-	-
Housewives	2	-	1	-	-
Clerical & Inspector Grades	-	1	-	1	1
Businessmen	10	16	6	7	8
Proprietors	2	1	1	2	2
Professional Grades	1	2	-	-	-
Administrative Grades	-	-	-	-	-
Pensioners	-	-	-	-	-
Students	-	-	-	-	-
Drivers	1	9	2	23	19
UN-employed	5	5	12	19	9
Others	-	2	8	4	8
Total	108	96	107	131	124

Source: Department of Prisons

**DIRECT ADMISSIONS OF PRISONERS SENTENCED TO DEATH
BY TYPE OF OFFENCES**

Offences relating to prisoners serving death sentences are shown in item 1 under

" A " Criminal offences against persons and item 4 under " D " Other Offences, given in Table 4.12

PRISONERS RELEASED

PRISONERS RELEASED, 2009 - 2013

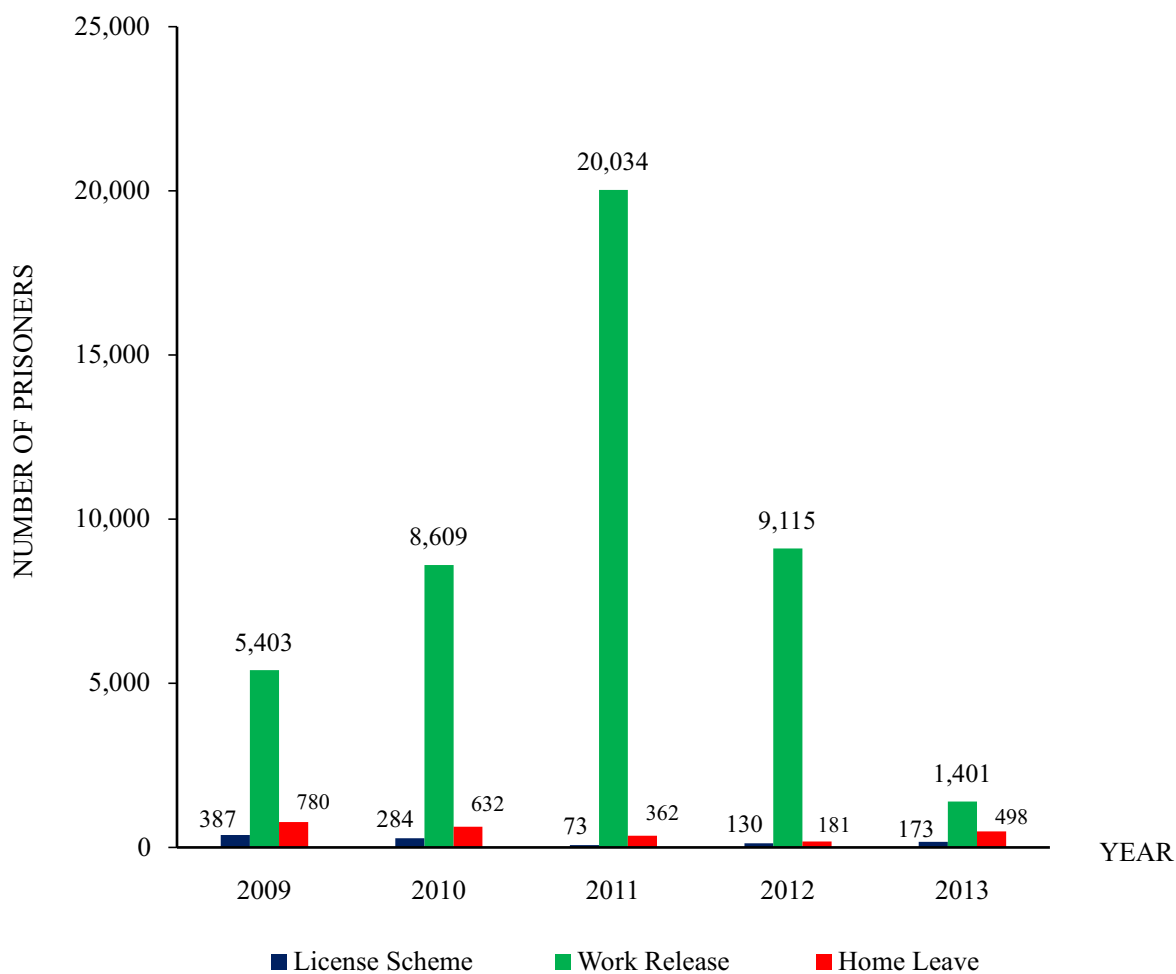

Table 7.1

**PRISONERS RELEASED ON WORK RELEASE , HOME LEAVE
AND ON LICENSE SCHEME, 2003 - 2013**

Year	Work Release	Home Leave	License Scheme
2003	210	267	108
2004	559	528	104
2005	320	364	153
2006	553	496	124
2007	1,068	547	208
2008	1,001	608	356
2009	5,403	780	387
2010	8,609	632	284
2011	20,034	362	73
2012	9,115	181	130
2013	1,401	498	173

Source: Department of Prisons

Table 7.2

PRISONERS ENGAGED ON WORK RELEASE SCHEME, 2003 - 2013

Year	No.of Prisoners Engaged on Work Release	No. of Found Unsuitable	Total Amount Earned for the Year (Rs.)
2003	210	22	2,625,641
2004	559	45	3,280,110
2005	320	44	3,276,166
2006	553	33	3,659,026
2007	1,068	29	4,957,205
2008	1,001	42	7,156,654
2009	5,403	45	7,454,635
2010	8,609	3	6,465,107
2011	20,034	3	8,082,040
2012	9,115	17	5,609,405
2013	1,401	18	2,118,240

Note : Number released for work outside includes 11 women for 2004

Source: Department of Prisons

Table 7.3**PRISONERS RELEASE ON LICENCE SCHEME, 2003 - 2013**

Year	No. of Released			No. whose License were Revoked for Violation conditions			No. Taken into Custody Again		
	Male	Female	Total	Male	Female	Total	Male	Female	Total
2003	108	-	108	1	-	1	-	-	-
2004	103	1	104	3	-	3	-	-	-
2005	152	1	153	10	-	10	-	-	-
2006	123	1	124	16	-	16	-	-	-
2007	206	2	208	10	-	10	-	-	-
2008	354	2	356	28	-	28	-	-	-
2009	379	8	387	37	-	37	19	-	19
2010	275	9	284	25	1	26	12	-	12
2011	70	3	73	24	1	25	8	1	9
2012	125	5	130	8	-	8	5	-	5
2013	166	7	173	6	1	7	2	-	2

Source: Department of Prisons

Table 7.4**PRISONERS SENT ON HOME LEAVE SCHEME, 2003 - 2013**

Year	No. Sent on Home Leave			No. Violated Law		
	Male	Female	Total	Male	Female	Total
2003	265	2	267	3	-	3
2004	523	5	528	3	-	3
2005	361	3	364	9	-	9
2006	490	6	496	9	-	9
2007	537	10	547	14	-	14
2008	602	6	608	10	-	10
2009	755	25	780	25	-	25
2010	618	14	632	21	-	21
2011	358	4	362	11	-	11
2012	175	6	181	6	-	6
2013	492	6	498	18	-	18

Source: Department of Prisons

VALUE OF INDUSTRIAL & AGRICULTURAL OUTPUT

VALUE OF INDUSTRIAL & AGRICULTURAL OUTPUT, 2009 - 2013

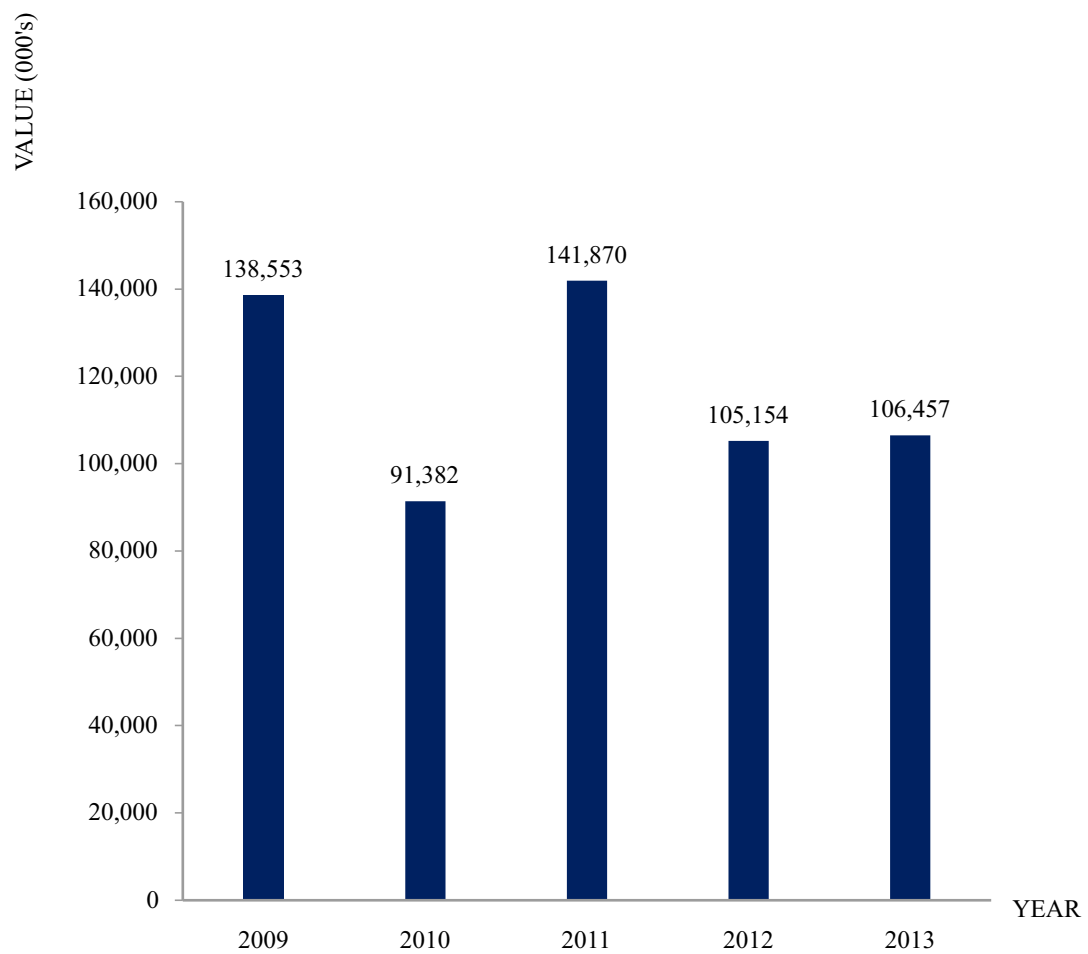

Table 8.1

VALUE OF INDUSTRIAL & AGRICULTURAL OUTPUT, 2009 - 2013

Item	Year											
	2009		2010		2011		2012		2013			
	Rs.	%	Rs.	%	Rs.	%	Rs.	%	Rs.	%	Rs.	%
Carpentry, Polishing	2,834,247	2.0	4,521,086	5.0	5,358,274	3.8	7,339,607	7.0	5,422,384	5.1		
Tailoring	6,032,250	4.4	2,018,291	2.2	4,369,196	3.1	6,886,571	6.5	5,889,371	5.5		
Laundry	1,259,024	0.9	1,513,574	1.7	1,527,494	1.1	1,570,458	1.5	1,953,094	1.8		
Black smithy	4,107,586	3.0	7,456,036	8.2	9,725,311	6.9	7,285,172	6.9	13,190,245	12.4		
Shoe Making	1,260	-	-	-	-	-	-	-	-	-		
Coir Making	2,760,287	2.0	1,463,295	1.6	2,274,315	1.6	3,054,961	2.9	2,756,204	2.6		
Cap Making	510	-	-	-	-	-	-	-	-	-		
Printing	1,054,565	0.8	581,382	0.6	744,971	0.5	1,275,505	1.2	2,573,806	2.4		
Bakery	47,853,929	34.5	39,611,873	43.3	29,129,378	20.5	36,143,574	34.4	33,853,687	31.8		
Motor Mechanism	1,350,702	1	7,584,487	8.3	1,418,420	1.0	1,941,639	1.8	2,902,371	2.7		
Weaving	3,512,866	2.5	1,194,332	1.3	2,432,489	1.7	4,695,467	4.5	3,454,868	3.2		
Masonry	5,812,763	4.2	3,381,751	3.7	5,708,300	4.0	1,097,771	1.0	2,108,998	2.0		
Soap Making	1,118,755	0.8	1,161,830	1.3	822,550	0.6	885,865	0.8	613,243	0.6		
Cane Products	-	-	-	-	-	-	-	-	-	-		
Bricks Making	2,001,913	1.4	1,836,450	2.0	1,046,100	0.7	1,139,636	1.1	1,624,835	1.5		
Animal Husbandry	30,397,740	21.9	664,869	0.7	3,502,648	2.5	3,380,217	3.2	1,865,313	1.8		
Agriculture	27,118,446	19.6	17,309,205	18.9	27,480,827	19.4	25,122,725	23.9	25,950,235	24.4		
Plumbing	418,760	0.3	92,217	0.1	43,888,635	30.9	74,873	0.1	44,749	0.0		
Electricity	785,738	0.6	522,135	0.6	1,114,048	0.8	1,014,156	1.0	285,831	0.3		
Coconut Oil	6,750	-	36,500	-	-	-	90,300	0.1	8,400	0.0		
Welding	117,905	0.1	27,850	-	-	-	-	-	-	-		
Headgears, Yoghurt	-	-	-	-	-	-	-	-	-	-		
Rain Cort	660	-	-	-	-	-	-	-	-	-		
Candles, Joss sticks	7,160	-	-	-	-	-	-	-	-	-		
Papadam	-	-	-	-	-	-	-	-	-	-		
Cement blocks	-	-	64,525	0.1	203,530	0.2	80,360	0.1	589,180	0.6		
Envelopes	-	-	341,000	0.4	1,023,000	0.7	1,763,040	1.7	935,775	0.9		
Shoe stickers	-	-	-	-	69,218	-	23,250	0.0	184,400	0.2		
Miscellaneous	-	-	-	-	31,975	-	289,700	0.3	250,165	0.2		
Total	138,553,816	100.0	91,382,688	100.0	141,870,679	100.0	105,154,847	100.0	106,457,154	100.0		

Note : In 2007 under the Candles & Joss sticks, got the income Joss sticks only.

Under the Headgears & Yoghurt got the income, Yoghurt only in 2008.

Source: Department of Prisons

Table 8.2

COMPARATIVE STATEMENT OF COST OF SUPPLIES , 2012 - 2013

Item	Year					
	2012		2013			
	Cost of Articles Supplied by Industrial Institutions or Private Contractors (Rs.)	Cost of Articles Supplied by Prison Department to Government and Private Sector (Rs.)	Savings (Rs.)	Cost of Articles Supplied by Industrial Institutions or Private Contractors (Rs.)	Cost of Articles Supplied by Prison Department to Government and Private Sector (Rs.)	Savings (Rs.)
Laundry	9,422,750	1,570,458	7,852,292	11,718,564	1,953,094	9,765,470
Bakery	41,565,111	36,143,574	5,421,537	38,931,740	33,853,687	5,078,053
Printing	6,377,528	1,275,505	5,102,023	12,869,030	2,573,806	10,295,224
Blacksmithy	14,570,345	7,285,172	7,285,173	26,380,491	13,190,245	13,190,246
Carpentry, Polishing	11,009,411	7,339,607	3,669,804	8,133,577	5,422,384	2,711,193
Tailoring	16,766,428	6,886,571	9,879,857	14,723,429	5,889,371	8,834,058
Motor Mechanism	3,883,278	1,941,639	1,941,639	5,804,742	2,902,371	2,902,371
Cap Making	-	-	-	-	-	-
Soap Making	930,158	885,865	44,293	643,905	613,243	30,662
Coir Making	3,793,228	3,054,961	738,267	3,390,109	2,756,204	633,905
Weaving	7,043,200	4,695,467	2,347,733	5,182,302	3,454,868	1,727,434
Masonry	2,744,429	1,097,771	1,646,658	5,272,495	2,108,998	3,163,497
Plumbing	74,873	74,873	-	44,749	44,749	-
Animal Husbandry	3,380,217	3,380,217	-	1,865,313	1,865,313	-
Agriculture	25,122,725	25,122,725	-	25,950,235	25,950,235	-
Electricity	1,014,156	1,014,156	-	285,831	285,831	-
Coconut Oil	90,300	90,300	-	8,400	8,400	-
Welding	-	-	-	-	-	-
Shoe Making	-	-	-	-	-	-
Shoe Stickers	23,250	23,250	-	184,400	184,400	-
Rain Coat	-	-	-	-	-	-
Envelopes	1,763,040	1,763,040	-	935,775	935,775	-
Brick Making	1,139,636	1,139,636	-	1,624,835	1,624,835	-
Candles , Joss sticks	-	-	-	-	-	-
Cement blocks	80,360	80,360	-	589,180	589,180	-
Miscellaneous	492,690	289,700	202,990	348,295	250,165	98,130

Source: Department of Prisons

GENERAL

ESCAPES, RECAPTURED & NUMBER OF DEATHS, 2009 - 2013

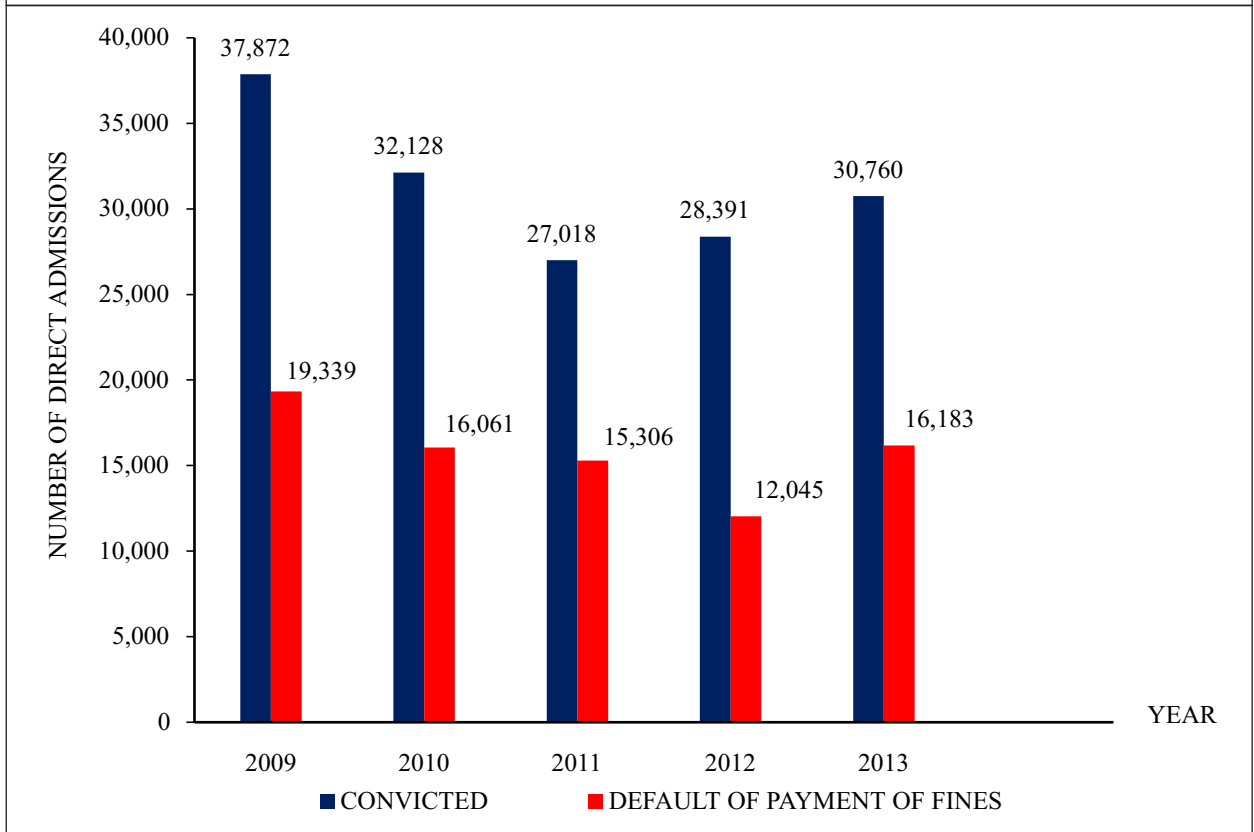
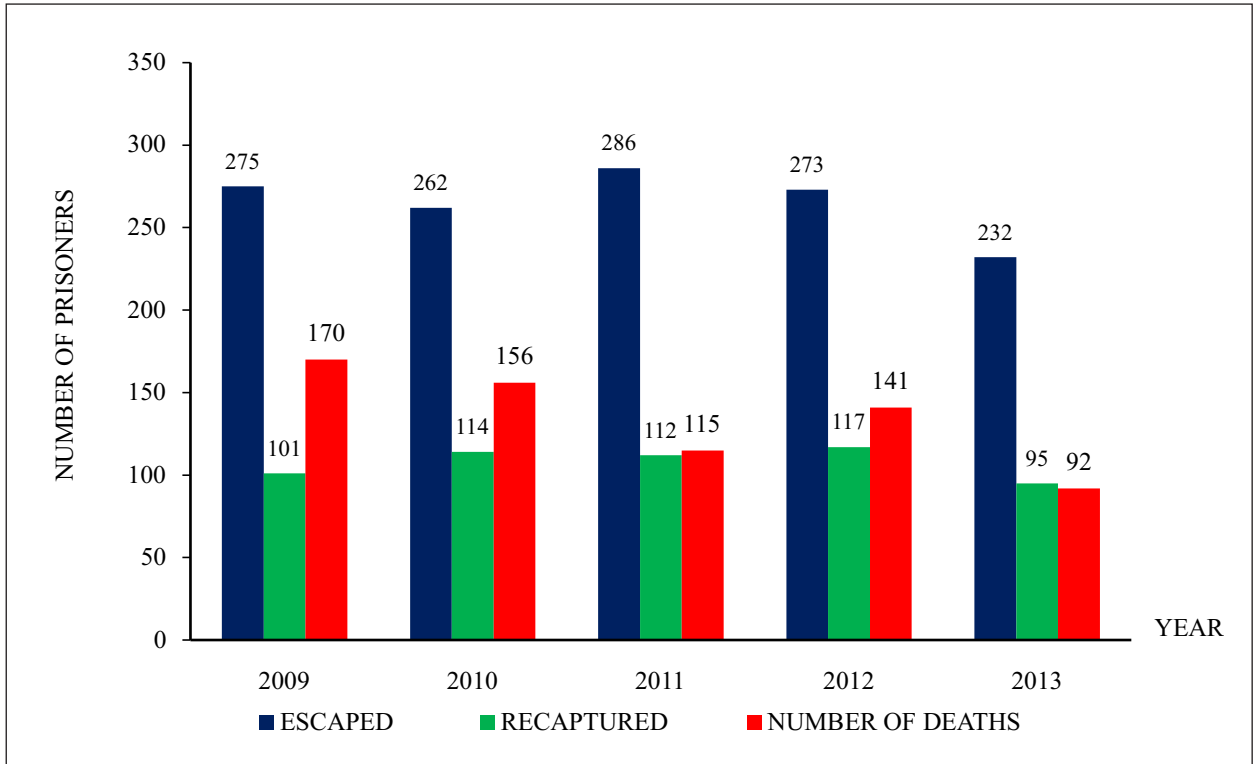

Table 9.1**PRISONERS ESCAPED RECAPTURED AND AT LARGE, 2004 - 2013**

Year	Total Admissions of Convicted and Unconvicted Prisoners	Daily Average Population of Convicted and Unconvicted Prisoners	Escapes	Percentage of Daily Population (Convicted and Unconvicted)	Recaptured	At Large
2004	114,354	20,661	541	2.62	99	442
2005	129,041	22,114	270	1.22	99	171
2006	117,922	22,867	216	0.94	66	150
2007	130,819	24,255	266	1.10	88	183
2008	135,811	26,124	258	0.99	121	137
2009	146,740	27,823	275	0.99	101	174
2010	132,319	26,984	262	0.97	114	148
2011	108,858	22,489	286	1.27	112	174
2012	136,151	23,603	273	1.16	117	156
2013	130,399	21,717	232	1.07	95	137

Source: Department of Prisons

Table 9.2**IMPRISONMENT FOR DEFAULT OF PAYMENT OF FINES, 2004 - 2013**

Year	Total Admissions of Convicted Prisoners	No.of Persons Imprisoned in Default of payment of Fines	Percentage to Total Admissions
2004	26,898	15,666	58.2
2005	33,034	16,244	49.2
2006	28,732	14,723	51.2
2007	31,306	15,408	49.2
2008	33,566	16,868	50.3
2009	37,872	19,339	51.1
2010	32,128	16,061	50.0
2011	27,018	15,306	56.7
2012	28,391	12,045	42.4
2013	30,760	16,183	52.6

Source: Department of Prisons

Table 9.3

THE POPULATION FIGURES OF CONVICTED PRISONERS BY INSTITUTIONS AS AT 1ST OF JANUARY AND 31ST OF DECEMBER OF EACH YEAR UNDER REFERENCE, 2012 – 2013

Institution	Year			
	2012		2013	
	Population as at 01.01.2012	Population as at 31.12.2012	Population as at 01.01.2013	Population as at 31.12.2013
Welikada prison	2,975	2,849	3,073	2,982
Colombo Remand prison	88	126	119	91
New Magazine Remand prison	156	135	133	170
Mahara prison	1,153	950	1,304	1,468
Bogambara prison	1,496	1,427	1,432	1,005
Kandy Remand prison	32	29	29	121
Jaffna Remand prison	33	44	54	64
Anuradhapura Remand prison	198	203	157	302
Badulla Remand prison	121	103	106	113
Batticaloa Remand prison	90	94	107	135
Galle Remand prison	136	134	132	175
Matara Remand prison	80	96	105	97
Tangalle Remand prison	140	94	84	114
Negambo Remand prison	248	312	306	308
Ambepussa T.S.Y.O.	65	61	61	59
Trincomalee Remand prison	56	62	61	101
Kegalle Remand prison	108	94	72	107
Kalutara Remand prison	302	322	270	346
Kuruwita Remand prison	241	301	299	334
Boosa Prison	207	207	206	179
Pallekelle Open Prison Camp	755	711	708	684
Meethirigala Work Camp	53	48	48	65
Homagama Work Camp	261	229	229	136
Weeravila Work Camp	674	471	469	402
Taldena C.C.Y.O	383	337	337	406
Kandewatta	47	64	63	80
Anuradhapura Work Camp	231	223	223	233
Pallansena C.C.Y.O.	358	338	336	516
Polonnaruwa Remand Prison	195	93	94	137
Monaragala Remand Prison	150	219	216	181
Wariyapola Work Camp	172	256	258	197
Vavuniya Remand Prison	33	15	-	30
Thunkama Work Camp	123	120	120	148
Hangilipola Work Camp	90	84	84	50
Total	11,450	10,851	11,295	11,536

Source: Department of Prisons

Table 9.4

POPULATION OF CONVICTED PRISONERS BY LITERACY AND SEX , 2004 - 2013

Year	Sex		Literate		Percent Literate	
	All Prisoners	Male	Female	All Prisoners	Male	Female
2004	26,898	26,113	785	25,134	24,455	679
2005	33,034	32,158	876	28,636	27,918	718
2006	28,732	27,755	977	24,927	24,199	728
2007	31,306	30,292	1,014	26,925	26,029	896
2008	33,566	32,558	1,008	31,034	30,172	862
2009	37,872	36,590	1,282	35,800	34,682	1,118
2010	32,128	31,096	1,032	29,283	28,386	897
2011	27,018	26,245	773	25,668	24,990	678
2012	28,391	27,445	946	26,421	25,581	840
2013	30,760	29,866	894	29,156	28,409	747

Source: Department of Prisons

Table 9.5

**THE NUMBER OF CONVICTED & UNCONVICTED PRISONERS
TREATED IN PRISON & CIVIL HOSPITALS , 2009 - 2013**

Position	Year			
	2009	2010	2011	2012
Outdoor Treatment				
Prison Hospital	237,002	286,275	243,692	237,229
Outside Clinics	13,975	17,698	12,868	13,106
Indoor Treatment				
Prison Hospital	55,367	26,071	27,201	26,206
General Hospital, Colombo	1,269	1,494	1,355	51
Ayurvedic Hospitals	1,167	344	895	936
Victoria Memorial Eye Hospital	15	166	35	9
Mental Hospital	454	288	208	216
Chest Hospital, Welisara	165	63	72	37
Other Hospitals	1,102	47	130	1,080
Total	310,516	332,446	286,456	278,870
				239,256
				17,308
				17,935
				2,530
				-
				3
				103
				34
				2,098
				279,267

Source: Department of Prisons

Table 9.6

NUMBER OF DEATHS & THE DEATH RATE , 2004 - 2013

Year	Total Annual Population of Convicted & Unconvicted Prisoners	Daily Average Population of Convicted & Unconvicted Prisoners	Number of Deaths (Convicted & Unconvicted)	Death Rate Per 1,000 Daily Average Population	Percentage of Deaths of the Daily Average Population (Convicted & Unconvicted)
2005	8,079,001	22,114	82	3.7	0.4
2006	8,772,189	22,867	48	2.1	0.2
2007	8,853,034	24,255	84	3.5	0.3
2008	9,535,172	26,124	155	5.9	0.6
2009	10,155,400	27,823	170	6.1	0.6
2010	9,849,212	26,984	156	5.8	0.6
2011	8,208,697	22,489	115	5.1	0.5
2012	8,615,095	23,603	141	6.0	0.6
2013	7,926,705	21,717	92	4.2	0.4

Note : Number of Deaths Included only Convicted Prisoners till 2007 and that number included Convicted and Unconvicted Prisoners for the Year 2008 and Onwards.
Source: Department of Prisons

Table 9.7

ACCOMMODATION & BUILDINGS, 2004 - 2013

Year	Authorized Accommodation			Daily Average Population			Percentage Overcrowding		
	Convicted	Unconvicted	Total	Convicted	Unconvicted	Total	Convicted	Unconvicted	Total
2005	6,181	4,511	10,692	10,898	11,216	22,114	76.3	148.6	106.8
2006	6,181	4,511	10,692	11,243	11,624	22,867	81.9	157.7	113.9
2007	6,181	4,511	10,692	11,906	12,349	24,255	92.6	173.8	126.9
2008	6,181	4,511	10,692	13,487	12,637	26,124	118.2	180.1	144.3
2009	6,673	5,034	11,707	13,694	14,129	27,823	105.2	180.7	137.7
2010	6,728	5,034	11,762	13,094	13,890	26,984	94.6	175.9	129.4
2011	6,728	5,034	11,762	11,104	11,385	22,489	65.0	126.2	91.2
2012	6,728	5,034	11,762	11,298	12,305	23,603	67.9	144.4	100.6
2013	6,728	5,034	11,762	9,508	12,209	21,717	41.3	142.5	84.6

Source: Department of Prisons

Table 9.8

RECURRENT EXPENDITURE, CAPITAL EXPENDITURE, THE AVERAGE COST PER PRISONER & COST OF FOOD PER PRISONER (Rupees), 2009 - 2013

	Year				
	2009	2010	2011	2012	2013
Recurrent Expenditure					
(1) Estimated	3,183,700,000	3,136,300,000	3,383,620,000	3,561,903,900	3,750,500,000
(2) Actual	3,079,326,207	3,132,019,693	3,362,171,827	3,404,071,757	3,747,039,347
Capital Expenditure					
(1) Estimated	241,970,000	193,100,000	335,950,000	389,480,000	1,092,224,000
(2) Actual	168,744,709	188,880,294	271,014,238	265,882,212	600,566,174
Average Cost Per Prisoner (Approximately)					
(1) Per Year	110,676	116,069	135,937	144,222	172,539
(2) Per Day	303	318	372	395	473
Average Cost of Food per Prisoner					
(1) Per Year	41,595	40,058	46,853	42,954	49,570
(2) Per Day	114	110	128	118	136

Note : Figures are based on the receipts submitted for the supply of food.

Source: Department of Prisons

NARCOTIC DRUG OFFENDERS

NARCOTIC DRUG OFFENDERS, 2008 - 2012

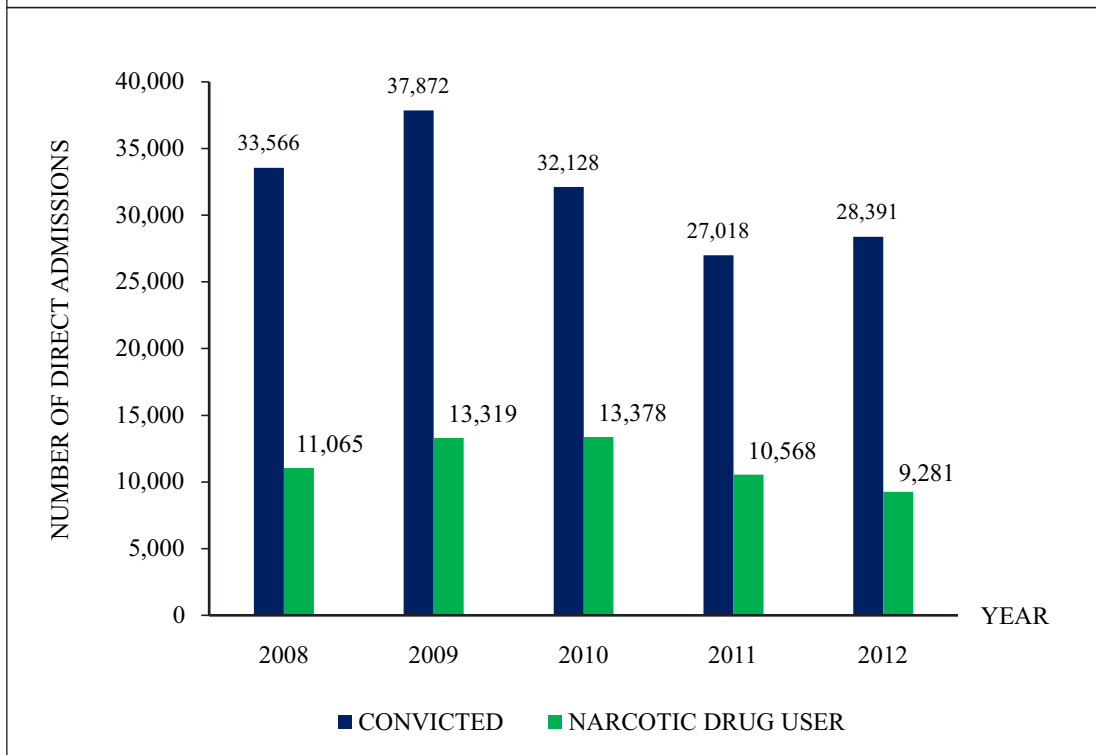
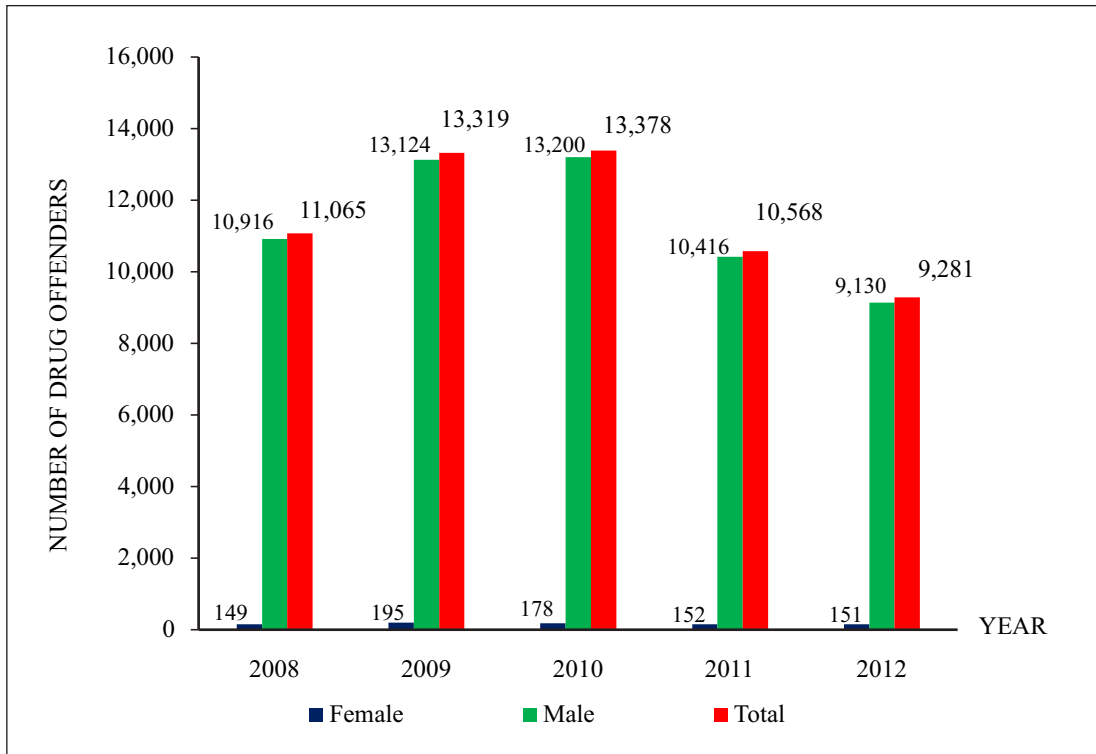

Table 10.1

DIRECT ADMISSIONS OF CONVICTED & NARCOTIC DRUGS OFFENCES, 2001 - 2012

Year	Convicted		Narcotic Drug User				%
	Male	Female	Total	Male	Female	Total	
2001	21,772	467	22,239	7,911	91	8,002	36.0
2002	24,409	614	25,023	9,740	77	9,817	39.2
2003	26,935	746	27,681	10,291	97	10,388	37.5
2004	26,113	785	26,898	10,379	140	10,519	39.1
2005	32,158	876	33,034	13,291	144	13,435	40.7
2006	27,755	977	28,732	10,214	170	10,384	36.1
2007	30,292	1,014	31,306	11,319	159	11,478	36.7
2008	32,558	1,008	33,566	10,916	149	11,065	33.0
2009	36,590	1,282	37,872	13,124	195	13,319	35.2
2010	31,096	1,032	32,128	13,200	178	13,378	41.6
2011	26,245	773	27,018	10,416	152	10,568	39.1
2012	27,445	946	28,391	9,130	151	9,281	32.7

Note : In 2004 information on the Galle Prison is also included
Source: Department of Prisons

Table 10.2

DRUG OFFENDERS ACCORDING TO TYPE OF DRUGS, 2001 - 2012

Year	Heroin	%	Cannabis	%	Opium	%	Tablets	%	Other	%	Total
2002	8,637	88.0	1,176	12.0	3	0.0	-	0.0	1	0.0	9,817
2003	9,076	87.4	1,307	12.6	-	0.0	-	0.0	5	0.0	10,388
2004	7,772	73.9	2,734	26.0	13	0.1	-	0.0	-	0.0	10,519
2005	8,861	66.0	4,565	33.9	9	0.1	-	0.0	-	0.0	13,435
2006	6,423	61.9	3,952	38.0	9	0.1	-	0.0	-	0.0	10,384
2007	6,386	55.7	5,065	44.1	25	0.2	2	0.0	-	0.0	11,478
2008	6,006	54.3	5,035	45.5	24	0.2	-	0.0	-	0.0	11,065
2009	7,003	52.6	6,300	47.3	10	0.1	6	0.0	-	0.0	13,319
2010	7,893	59.0	5,458	40.8	27	0.2	-	0.0	-	0.0	13,378
2011	7,183	68.0	3,382	32.0	3	0.0	-	0.0	-	0.0	10,568
2012	6,057	65.3	3,210	34.6	5	0.1	5	0.1	4	0.0	9,281

Source: Department of Prisons

Table 10.3
DRUG OFFENDERS ACCORDING TO DISTRICTS, 2001 - 2012

District	Year											
	2001	2002	2003	2004	2005	2006	2007	2008	2009	2010	2011	2012
Colombo	6,821	7,976	9,102	8,012	8,769	7,730	8,610	7,609	9,936	9,658	8,159	6,941
Gampaha	453	679	93	385	1,349	697	765	1,133	962	1,002	681	624
Kalutara	22	73	119	314	311	272	414	588	491	533	405	373
Kandy	128	183	189	341	665	459	279	302	330	291	104	134
Matale	11	20	19	20	3	37	45	98	46	35	20	30
Nuwaraeliya	4	7	8	14	23	35	58	71	53	23	18	30
Galle	200	339	167	219	614	192	184	219	212	518	418	267
Matara	41	58	72	89	322	48	59	34	42	57	27	43
Hambantota	43	67	71	107	93	94	102	66	60	81	60	68
Jaffna	-	3	5	4	5	2	1	1	6	6	4	9
Mannar	2	4	7	7	3	6	4	4	14	19	13	10
Vavuniya	2	1	26	32	48	17	8	3	8	13	7	12
Mullativu	-	-	-	-	-	-	-	-	-	1	3	3
Batticaloa	2	5	1	18	39	32	34	6	37	78	50	27
Trincomalee	28	27	38	120	78	37	77	91	216	138	20	49
Ampara	4	8	-	21	23	32	49	14	49	16	42	38
Kurunegala	52	89	116	146	217	133	150	171	175	251	150	121
Puttalam	28	41	48	67	139	56	60	83	68	75	48	56
Anuradhapura	52	77	94	106	140	109	121	128	177	186	76	134
Polonnaruwa	4	9	6	47	55	72	99	46	27	58	19	21
Badulla	18	30	16	126	117	76	92	106	127	79	55	63
Moneragala	15	21	78	92	97	59	87	62	42	57	33	50
Ratnapura	59	72	84	181	189	142	122	165	192	148	112	132
Kegalle	13	28	29	31	135	47	57	65	49	54	40	44
Kelinochchi	-	-	-	-	1	-	1	-	-	1	4	2
Other Countries	-	-	-	20	-	-	-	-	-	-	-	-
Not Respond	-	-	-	-	-	-	-	-	-	-	-	-
Total	8,002	9,817	10,388	10,519	13,435	10,384	11,478	11,065	13,319	13,378	10,568	9,281

Source: Department of Prisons

Table 10.4

DRUG OFFENDERS ACCORDING TO RACE, 2001 - 2012

Year	Sinhalese	%	Tamil	%	Muslim	%	Malay	%	Burgher	%	Others	%	Total
2001	5,602	70.0	1,073	13.4	1,241	15.5	41	0.5	45	0.6	-	0.0	8,002
2002	7,029	71.6	1,206	12.3	1,456	14.8	53	0.6	72	0.7	1	0.0	9,817
2003	7,288	70.1	1,369	13.2	1,627	15.7	34	0.3	69	0.7	1	0.0	10,388
2004	7,205	68.5	1,524	14.5	1,717	16.3	23	0.2	50	0.5	-	0.0	10,519
2005	9,519	70.9	1,662	12.4	2,204	16.4	18	0.1	30	0.2	2	0.0	13,435
2006	7,168	69.0	1,541	14.8	1,586	15.3	37	0.4	47	0.5	5	0.0	10,384
2007	7,781	67.8	1,688	14.7	1,879	16.4	41	0.4	75	0.6	14	0.1	11,478
2008	7,683	69.4	1,533	13.8	1,767	16.0	25	0.2	50	0.5	7	0.1	11,065
2009	8,887	66.7	2,057	15.5	2,264	17.0	40	0.3	66	0.5	5	0.0	13,319
2010	9,498	71.0	1,674	12.5	2,135	16.0	25	0.2	43	0.3	3	0.0	13,378
2011	7,231	68.4	1,554	14.7	1,733	16.4	20	0.2	29	0.3	1	0.0	10,568
2012	6,642	72.0	1,203	13.0	1,380	15.0	22	0.0	33	0.0	1	0.0	9,281

Source: Department of Prisons

Table 10.5

DRUG OFFENDERS ACCORDING TO RELIGION, 2001 - 2012

Year	Buddhist	%	Hindu	%	Islam	%	Roman Catholic	%	Other Christian	%	Others	%	Total
2001	5,128	64.1	784	9.8	1,234	15.4	509	6.4	347	4.3	-	0.0	8,002
2002	6,312	64.3	886	9.0	1,451	14.8	988	10.1	180	1.8	-	0.0	9,817
2003	6,728	64.7	1,082	10.4	1,622	15.6	868	8.4	80	0.8	8	1.0	10,388
2004	6,633	63.1	1,265	12.0	1,716	16.3	807	7.7	94	0.9	4	0.0	10,519
2005	8,692	64.7	1,444	10.8	2,219	16.5	1,048	7.8	30	0.2	2	0.0	13,435
2006	6,593	63.5	1,195	11.5	1,617	15.6	533	5.1	443	4.3	3	0.0	10,384
2007	6,859	59.8	1,296	11.3	1,934	16.8	942	8.2	445	3.9	2	0.0	11,478
2008	6,678	60.3	1,283	11.6	1,800	16.3	1,049	9.5	255	2.3	-	0.0	11,065
2009	7,982	59.9	1,609	12.1	2,278	17.1	705	5.3	744	5.6	1	0.0	13,319
2010	9,088	67.9	1,489	11.1	2,159	16.2	425	3.2	214	1.6	3	0.0	13,378
2011	6,899	65.3	1,432	13.6	1,726	16.3	274	2.6	234	2.2	3	0.0	10,568
2012	5,902	63.6	892	9.6	1,409	15.2	742	8.0	336	3.6	-	0.0	9,281

Source: Department of Prisons

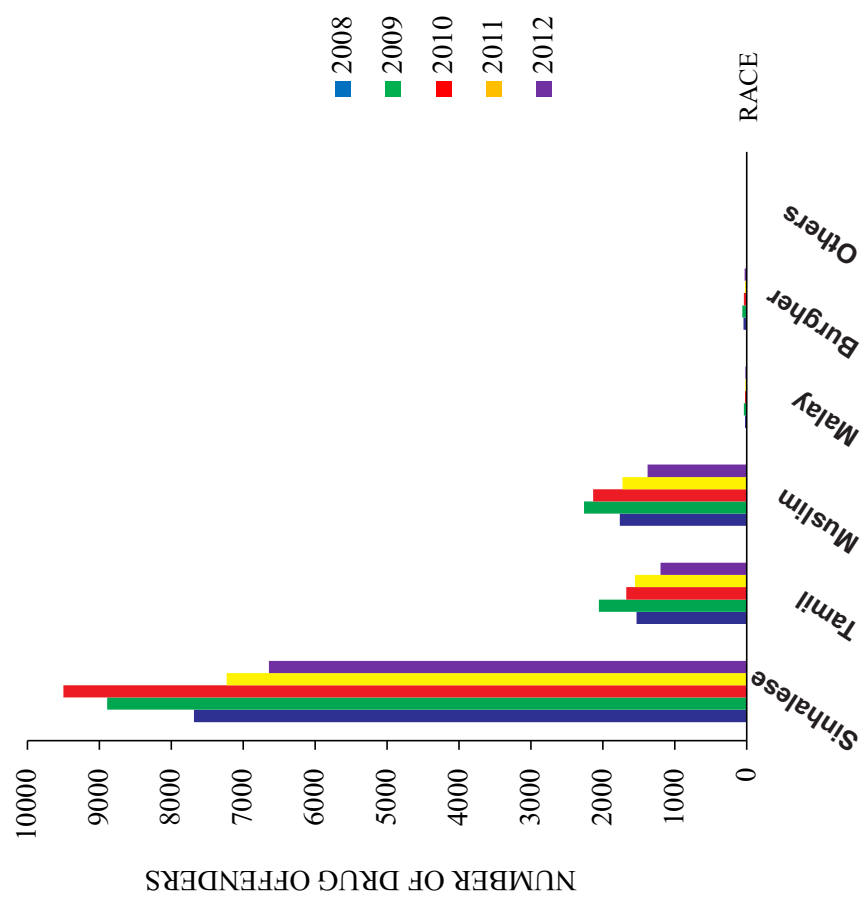
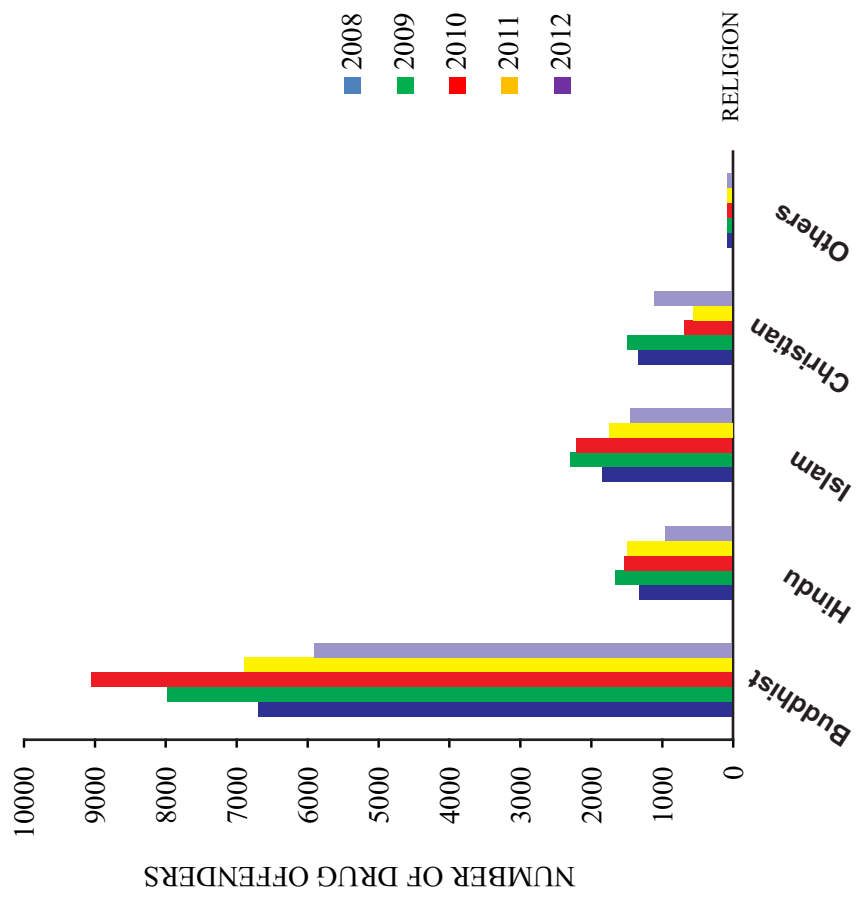

Table 10.6

DRUG OFFENDERS ACCORDING TO AGE GROUPS , 2001 - 2012

Year	Under 16 Years	16-22	22-30	30-40	40-50	Above 50 Years	Not Mentioned	Total
2001	-	818	2,510	3,270	1,171	233	-	8,002
2002	2	933	2,962	3,974	1,581	365	-	9,817
2003	2	843	3,120	4,096	1,848	460	19	10,388
2004	1	957	3,091	3,936	2,003	529	2	10,519
2005	-	1,081	3,976	4,770	2,750	856	2	13,435
2006	-	786	2,762	3,663	2,386	787	-	10,384
2007	4	904	3,047	3,845	2,790	888	-	11,478
2008	10	912	2,932	3,666	2,668	877	-	11,065
2009	7	1,003	3,183	4,321	3,525	1,279	1	13,319
2010	4	994	3,101	4,304	3,570	1,405	-	13,378
2011	7	897	2,325	3,384	2,699	1,256	-	10,568
2012	3	625	2,046	3,002	2,501	1,104	-	9,281

Source: Department of Prisons

Table 10.7

DRUG OFFENDERS ACCORDING TO EDUCATIONAL LEVEL , 2001 - 2012

Year	No Schooling	Grade 1-5	Grade 6-9	G.C.E. O/L , A/L	Graduated	Prof. Quali.	Others	Total
2001	1,334	2,107	2,590	1,953	9	-	9	8,002
2002	1,605	2,439	3,492	2,271	10	-	-	9,817
2003	1,812	2,578	3,313	2,678	5	2	-	10,388
2004	1,687	2,906	3,322	2,596	8	-	-	10,519
2005	1,007	3,023	7,294	2,103	8	-	-	13,435
2006	1,774	2,503	3,591	2,513	3	-	-	10,384
2007	1,879	2,806	4,921	1,863	9	-	-	11,478
2008	1,564	2,586	4,249	2,658	7	1	-	11,065
2009	1,924	3,155	4,871	3,360	8	1	-	13,319
2010	1,626	3,021	5,637	3,090	4	-	-	13,378
2011	1,124	1,912	4,669	2,861	2	-	-	10,568
2012	1,375	2,055	3,178	2,668	4	1	-	9,281

Source: Department of Prisons

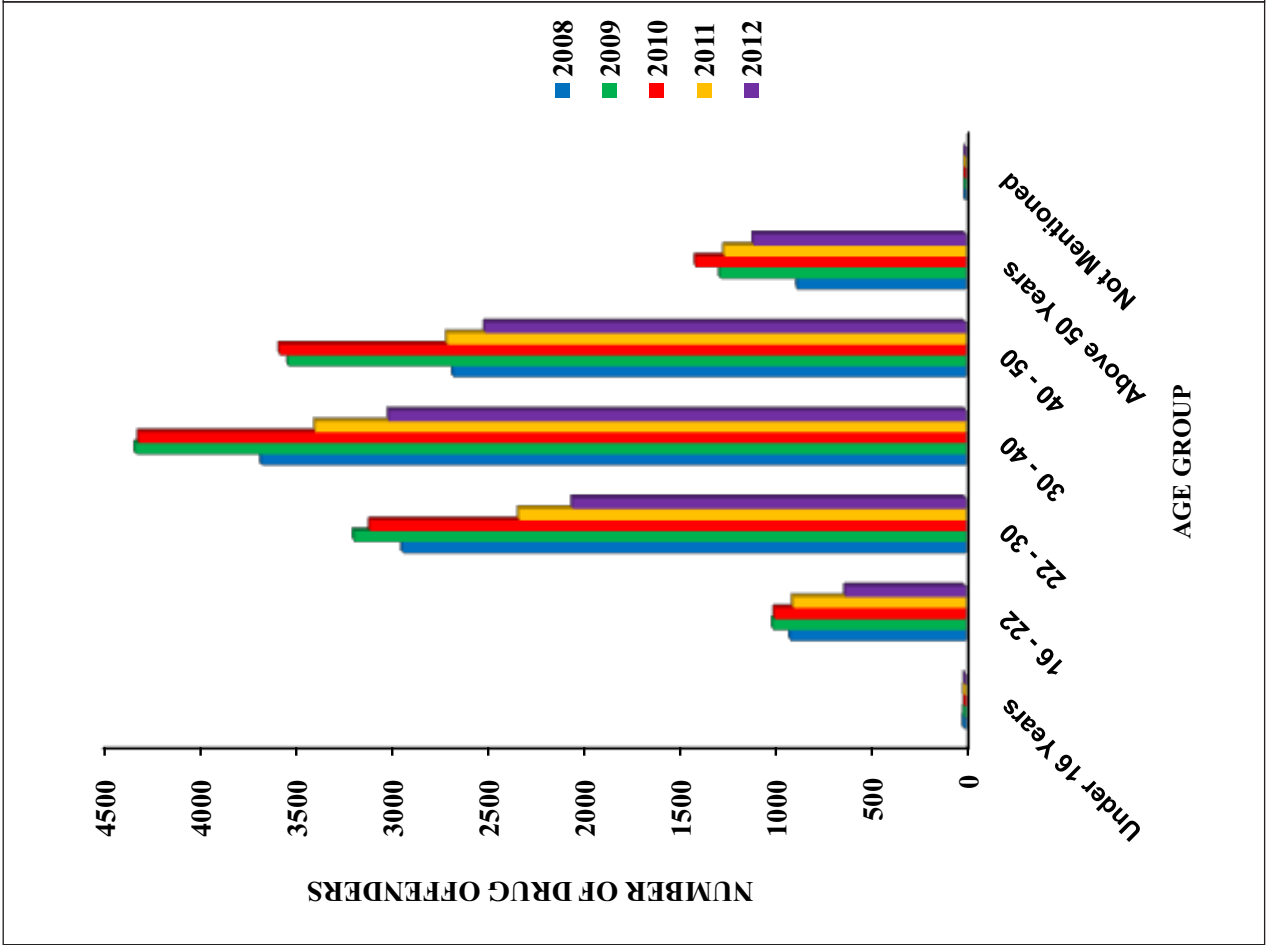
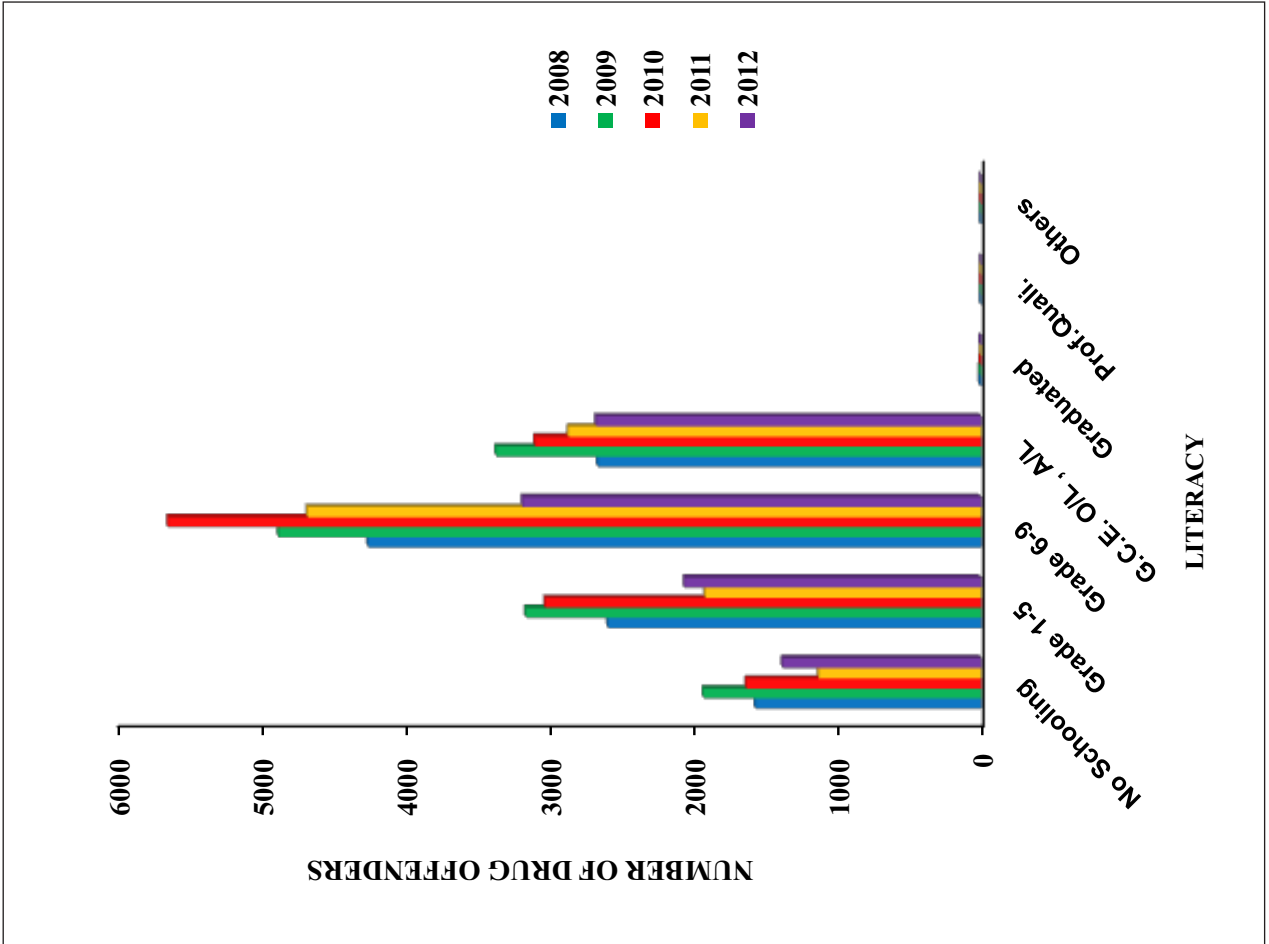

Table 10.8

DRUG OFFENDERS ACCORDING TO MARITAL STATUS , 2001 - 2012

Year	Never Married	Married	Widowed	Divorced	Legally Separated	Total
2001	4,877	3,099	24	2	-	8,002
2002	5,966	3,840	11	-	-	9,817
2003	6,082	4,292	8	6	-	10,388
2004	6,045	4,461	8	5	-	10,519
2005	5,066	8,340	25	4	-	13,435
2006	5,802	4,578	3	1	-	10,384
2007	6,529	4,934	13	2	-	11,478
2008	6,268	4,785	10	2	-	11,065
2009	7,045	6,242	18	12	2	13,319
2010	7,141	6,221	9	7	-	13,378
2011	5,972	4,592	2	2	-	10,568
2012	5,096	4,168	16	1	-	9,281

Source: Department of Prisons

Table 10.9

DRUG OFFENDERS ACCORDING TO PERIOD OF SENTENCE , 2001 - 2012

Year	Under 01 Month	01 Month - 06 Months	06 Months - 01 Year	Above 01 Year	Death Sentence & Life Sentence	Total
2001	311	5,263	1,600	827	1	8,002
2002	1,070	5,433	1,878	1,436	-	9,817
2003	610	4,297	2,636	2,844	1	10,388
2004	750	4,606	2,740	2,423	-	10,519
2005	489	6,471	3,710	2,765	-	13,435
2006	294	5,676	1,651	2,761	2	10,384
2007	197	6,411	1,673	3,191	6	11,478
2008	212	6,462	1,951	2,421	19	11,065
2009	359	7,813	2,236	2,897	14	13,319
2010	393	9,746	1,455	1,754	30	13,378
2011	192	6,280	2,219	1,868	9	10,568
2012	214	6,192	1,765	1,078	32	9,281

Source: Department of Prisons

Table 10.10

DRUG OFFENDERS ACCORDING TO PARENTS ALIVE OR NOT , 2001 - 2012

Year	Yes		No	
	Farther	Mother	Farther	Mother
2001	3,501	5,534	4,501	2,468
2002	4,506	7,260	5,312	2,556
2003	4,514	7,635	5,874	2,753
2004	4,515	7,520	6,004	2,999
2005	9,532	10,756	3,903	2,679
2006	4,061	7,298	6,323	3,086
2007	4,536	8,107	6,942	3,371
2008	4,967	7,605	6,098	3,460
2009	5,379	9,183	7,940	4,136
2010	5,403	9,910	7,975	3,468
2011	4,718	8,279	5,850	2,289
2012	3,798	6,410	5,483	2,871

Source: Department of Prisons

Table 10.11

DRUG OFFENDERS ACCORDING TO FIRST OFFENDERS & RECIDIVIST - 2012

Year	First Offenders	Reconvicted	Recidivist	Total	Percentage		
					First Offenders	Reconvicted	Recidivist
2011	2,330	6,165	2,073	10,568	22.0	58.4	19.6
2012	2,572	4,346	2,363	9,281	27.7	46.8	25.5

Source: Department of Prisons

CHRONOLOGY

(Extract from "History of Prisons in Sri Lanka")

- 1802 - The then existing barbarous methods of punishments were banned and causing of death by hanging was introduced by Governor Sir Fredrick North.
- 1812 - The first person to be hanged on a fixed gallows, in the history of Prisons on 10th February. The death sentence was imposed on him for rising against the British Government.
- 1818 - After the rebellion 53 people including Ehalepola Adhigari were detained at Ehalepola Adhigaram's residence by the British, which is presently known as Kandy Remand.
- 1844 - First Prison Ordinance was enacted, entitled "An Ordinance for the better regulation of Prisons Act No.18 of 1844", Establishment of Welikada Prison.
- 1853 - An Ordinance for the safe custody of convicts employed upon public works Act No. 02 of 1853.
- 1866 - An Ordinance to amend the Ordinance No.18 of 1844, the 9th and 10th sub-sections of the 31st section. 70th and 71st sections of the Fiscals Ordinance of 1866. Act No.20 of 1866.
- 1867 - 1st Prison Commission-Prison Disciplinary Commission No.1 of 1867 pingo carrying as punishment was introduced.
- 1869 - An Ordinance to convert the Welikada and Hultsdorf Prisons into Central Convict Establishments and to vest in the Superintendent thereof certain powers vested in the Fiscal of Western Province Act No.16 of 1869.
- Prison Ordinance Act No.16 of 1869, establishment of uniformed prison system under the control of Inspector General of Prisons.
- Prison Discipline Commission II of 1869, system of giving guard conduct marks was introduced and remitting of the terms of their imprisonment.
- 1871 - The first gallows was built in the Welikada Prison on 25th May.
- 1875 - Establishment of Mahara Prison.
- 1876 - Establishment of Bogambara Prison.
- 1877 - 1905 The supervisions and control of all prisons in the Island were vested in Inspector General of Prisons. From its inception the office of Inspector General of Prisons was held by the Inspector General of Police until 1905 when they separated. Major de Wilton who till then held both offices was appointed Inspector General of Prisons and he was also appointed to be the Superintendent of the Prisons at Welikada, Mutwal and Hultsdorf.
- 1883 - An Ordinance to provide a general penal code for the colony sentence of death carried into effect within the walls of the prison in which the prisoner is confined at the time of execution (Ordinance No.3 of 1883).
- 1885 - Campbell Park, at the request of Mr. Campbell the Government granted a 20 acres of ground in the neighborhood of Welikada for a public Recreation Club. Prisoners were employed in this work.
- 1900 - A prison riot took place at Mahara quarry. Entire Sinhalese staff was removed and were replaced by Malay staff.

- 1905 - The Department of Prisons was separated from the Department of Police as an independent Department on 16th July.
- 1911 - The printing machinery at Welikada Prison was given to the Government Printing Press and two hundred prisoners were sent daily to work at the Press.
- 1918 - 1920 Introduction of a board system of classification by institutions, first offenders, juveniles, females and reconvicted prisoners were located in separate institutions. Also short term and long term first offenders as well as star class prisoners and the better type of reconvicted men were further classified and housed in different sections of the larger prisons.
- 1920 - 1925 Organization of large scale prison industries at Welikada and Bogambara Prisons and smaller ones at other institutions. A complete steam laundry was set up at Welikada capable of handling thousands of pieces of linen from Colombo Hospitals and for washing prisoners' clothing and other textile requirements were supplied at Welikada. In these trades and a system of making supplies to all Government Departments was adopted.
- 1922 - The convicted settlements at Andaman's were closed down and 62 life convicts sent back to Ceylon. The sentence was reduced to 20 Years rigorous imprisonment, with the privilege of prison remission.
- The term of imprisonment of the prisoners sentenced to Life, was commuted to a 20 year imprisonment for the first time on 22nd February.
- 1923 - Establishment on July 1st, 1923 Prison Department Mutual Provident Fund for the benefit of the subordinate staff of the department and with the object of promoting thrift, affording relief by means of loans to its members in times of sickness or distress and of making provisions for themselves, widows and orphans.
- 1926 - Application of Scout principles in the training of youthful offenders was introduced and the Welikada Prison troop was registered by the Imperial Scout Headquarters as the 1st troop of its kind in the world.
- 1931 - Report of the Prisons inquiry Commission 1931. Sessional Paper 1 of 1932 (Gavin Commission Reports)
- 1932 - Sessional paper XVII - 1932. Report of the Committee appointed to consider the question of prison industries.
- Establishment of Magazine Remand Prison.
- 1933 - 1936 Direct recruitment to the middle and exclusive grades commenced. System of local visiting committee introduced. Strict provisions introduced for the investigation of prisoners' complaints.
- Series of prison offences such as escapes, assaults of prison officers made triable by District Judge and a Tribunal.
- 1936 - Former training officers. 20 officers were recruited and a 3 month training was given. 12 completed the training course.
- 1937 - A Prison Officers' Training centre was started in 1937 and all subordinate officers in the institutions side were recruited as learner guards and received 3 months course of training at training centre.
- 1939 - An Ordinance to amend the Prison Ordinance Number 53 of 1939.
- 1940 - Establishment of the Training School for Youthful Offenders at Wathupitiwala, the 1st Open Borstal Institution in Asia for Youth Offenders.

- 1944 - Introducing of the Probation system as a branch of the Prison Department Recruitment and training of the first batch of officers.
- 1946 - 1955 Expansion of the Probation Service to cover all the judicial areas of the country. Organization of Remand Houses, Certified Schools and Probation Hostels.
- 1949 - Report of the Special Committee on Prison Administration sessional Paper XVIII.
Gratien Commission Report.
- 1950 - Establishment of the Open Prison at Pallekelle, the 1st of the kind in Asia.
- 1952 - Commencement of scheme for senior officers to be sent abroad for training and further study under the Colombo Plan under various fellowship schemes.
- 1952 - 1954 Organization of the Building Branch of the Department.
- 1954 - Establishment of C.C.Y.O. at Negombo.

Break Water and Slave Island - These prisons were closed by order of the Minister published in the Gazette No.10640 of 12th February.
- 1956 - Suspension of the death penalty in Sri Lanka. Separation of the Probation Service from the Department of Prisons to form the nucleus of a new Department called the Department of Probation and Child Care Services.

Entire Fiscal Establishments were handed over to the Department of Prisons.
- 1956 - 1957 Transfer of all fiscal lock-ups in the country to the Prison Department.
- 1957 - 1958 Establishment of Open Camps at Anuradhapura, Batticaloa and Jaffna.
- 1958 - Introduction of the 9 hour working day for all Prison staff and system of payment of overtime to all officers of and below the rank of Jailor.
- 1959 - Appointment of a Commission on the Death Penalty in Sri Lanka under the Chairmanship of Professor Norval Morris - Sessional Paper XIV of 1959.
- 1960 - Re-introduction of death penalty.
- 1968 - Increase of remission from 1/4 to 1/3.
- 1971 - Insurgency - sudden influx of about 17,000 persons to prison institutions and camps causing disruption of normal prison activities.
- 1971 - 1975 Departmental officer deployed to assist in the rehabilitation of insurgents who were alleged to be marginally involved in the attempted insurrection.
- 1974 - Establishment of the Experimental Prisoners Co-operative farm at Mithirigala, abolition of star class prisoners, Formation of Discharged Prisoners Co-operative introduction of the work release scheme.
- 1975 - Establishment of the Centre for Research and training in Correction with residential facilities for 40 trainees at a time. Service of two U.N. Experts adequate staff training, programmed pre-service and in-service training course for all obtained to set up staff was organized.
- 1976 - Establishment of Pallansena Open Correctional Centre.

- 1977 - Increase of staff approved through the Management Service Division of the Ministry of Public Administration.
- 1977 - 1978 Establishment of Weerawila Open Work Camp.
- 1978 - Library at the Center, Research and Training in Correction.
Formation of National Association for Prevention of Crime and Delinquency.
- 1979 - 1980 A system of work camps for short-term and medium-term prisoners was introduced.
Publication of the first issue of the 'Prison Statistics of Sri Lanka' compiled by Mr. K. L. C. Athukorala, Ex-Statistical officer, Prisons Headquarters.
- 1981 Opening of the Family Rehabilitation Centre, Senapura.
- 1982 - Prison Lock-ups at Kegalle and Trincomalee were up graded to the status of Remand Prisons with effect from 20.01.1982.
In February, 1982 the two (2) institutions which were opened as " WORK CAMPS FOR YOUNG OFFENDERS " Pallansena and Taldena respectively were subsequently renamed as " CORRECTIONAL CENTRES FOR YOUTHFUL OFFENDERS " .
- 1983 - Unprecedented increase of unconvicted prisoners' administration owing to the state of emergency following the ethnic disturbances of July, 1983.
Welikada Prison, Colombo figured prominently in this ethnic disturbance, when on 25th and 27th July 1983, 53 Tamil detainees were killed by other prisoners in a Prison riot which broke out immediately after violence broke out in the country. The inquest into the details was held by the chief Magistrate Colombo assisted by Senior Attorney from the Attorney General's Department and the verdict was homicide due to a prison riot.
- 1984 (i) Nawajeevanagama colony established for 300 discharged prisoners at Padaviya was attacked by Tamil Terrorists on 30th November, 1984 killing 56 discharged prisoners and members of their families.
(ii) Inauguration of UNESCO Club in Welikada and Bogambara Prisons (First UNESCO Club in prisons in the Island).
(iii) A sudden increase of those admitted to prison for drug offences from 580 in 1980 to 1777 in 1984.
- 1985 - Centre for Research and Training in Corrections which was established with the UNDP assistance completed 10 years on 30th April, 1985.
The closure of Jaffna Prison on 12.05 1985 and the shifting of the Superintendent's Office to the Magistrate Banglow at Old Park Road , Jaffna. All the inmates were relocated at Negombo Prison.
Family rehabilitation centre at Senapura was handed back to the Department of Social Services in April 1985.
The Open Prison Camp at Kopay was attacked by Tamil Terrorists who destroyed the buildings with all valuable articles in May, 1985.
Establishment of a permanent centre " Legal Aid " for the benefit of remand prisoners at the Magazine Remand Prison in collaboration with the Legal Aid Council.

- 1985 - (O.S.M.Seneviratne Commission) Appointing of a Committee to consider changing the practice procedure and rules,related to prisons having regard to changed circumstances headed by Hon.Justice O.S.M.Seneviratne,Justice of the Supreme Court.
- 1986 - Establishment of a Transit camp at Pelawatta in the Kalutara District for a certain category of persons arrested under the Prevention of Terrorism Act.
- 1987 - Inauguration of Seva Vanitha Unit of the Department of Prisons on 11th March 1987 by Mrs.C.Ranaraja the president of the Seva Vanitha Unit of the Ministry of Justice.
- The Magazine Remand Prison which was confined to ordinary remand prisoners was set apart to detainees who have been arrested under the Prevention of Terrorism Act and Emergency Regulations with effect from 7th May 1987.
- 1988 - Unprecedented " under prevailed in Prisons viz.Welikada,Bogambara, Magazine Remand and Transit Camp at Pelawatta,as a consequence of the unfavourable conditions existed in the Island towards the latter part of the year.The prison riot of November 1988 which took place in Welikada Prison caused a considerable destruction to office buildings and stores. Also there was a major escape of detainees numbering 221 who had been in custody under the Prevention of Terrorism Act from Magazine Remand Prison and 131 of them who were also in detention under the same Act at Pelawatta Transit Camp.
- 1989 - For the first time in the history of Prisons Department the Officers from Welikada, Mahara and some other prisons were out of duty points demanding higher salary scales, extra set of uniforms and welfare amenities,for them.This was not an organized strike but walk out due to the conditions prevailed in this country, During this period. most of the demands were granted,like an undertaking to increase salaries and other welfare amenities within 24 hours.During this period the security of those prisons was taken up by security forces.
- 1990 - The Work Camp at Weerawila has been converted to a camp for terrorist detainees with effect from 29th June 1990.
- Navodawa a Rehabilitation Center inaugurated to reform inmates convicted on charges of dangerous drug addiction.
- 1991 - In 04th August 1991 opening of the Remand Prison,Kalutara.
- Koggala Work Camp was closed down in 31st December 1991 to make way for a Free Trade Zone.
- 1993 - Establishment of Kuruvita Work Camp.
- 1995 - Ceremonial dress for Prison Officers.
- 1996 - Weerawila Work Camp was taken over from the Ministry of Defence.
- A project under which awarding of scholarships to the children of employees of the Department of Prisons was established.
- Committee to examine the existing Legal Provisions and Administration Practice, relating to the welfare of prisons-Headed by Walter Ladduwahetti.
- 1997 - Re-establishment of Jaffna Prison.
- 1999 - Kuruwita work camp was supplemented with a Remand Prison.
- Inauguration of the Boossa Prison.
- 2002 - Establishment of Wariyapola Open Work Camp.

- 2002 - Conversion of Lock-ups at Polonnaruwa and Monaragala into Remand Prisons.
Handing over the Ratnapura Lock-up to the Ratnapura Police.
The Department of Prison was transferred to the Ministry of Interior.
- 2003 - Radio signals system was established between Colombo and Mahara Prisons.
- 2006 - Establishment of an open school at Pallansena.
Female section of the Welikada Prison was detached and attached to the Magazine Remand Prison.
- 2007 - Inauguration of Sri Lanka Prisons Day on 16th July.
A memorial was built in memory of Prison officers who died on duty.
Inaugural Colours Night of the Department of Prisons was held for the merits of sports.
Introduce Prison song for the Department of Prisons.
- 2008 - Female section of the Magazine Remand Prison was detached and again attach to the Welikada Prison.
Commencement of the registration of convicted prisoners in Mahara Prison.
Commencement of the Women's section at the Matara Prison.
Commencement of the work camp in Thunkama , Embilipitiya.
Lock-up in Kalutara, under the authority of Urban Council of Kalutara.
- 2009 - Establishment of Remand Prison in Vavuniya.
Established of a security and Intelligence Division.
Training school for Youthful offender's in Pallansena was shifted to Ambepussa.
- 2010 - Commencement of the work camp in Hangilipola.

TOTAL NUMBER OF DIRECT ADMISSIONS OF CONVICTED PRISONERS FOR 2013 - 30,760

Narcotic Drug Offenders	-	10,448
Condemned Prisoners (Death Sentence)	-	124
Youthful Offenders	-	29
Other Convicted Prisoners	--	<u>20,159</u>
TOTAL		<u><u>30,760</u></u>

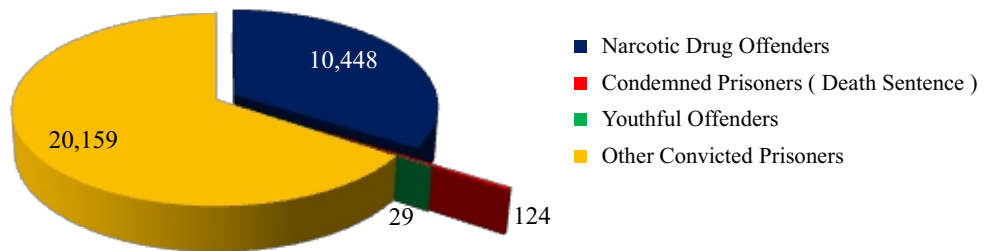

TOTAL NUMBER OF DISCHARGE PRISONERS FOR -2013

31,838 *

On punishment	-	19,431
On bail	-	241
On payment of fines	-	9,950
On special occasions	-	<u>2,216</u>
TOTAL		<u><u>31,838</u></u>

Tiles Number Includes Imprisoned during 2013 and from

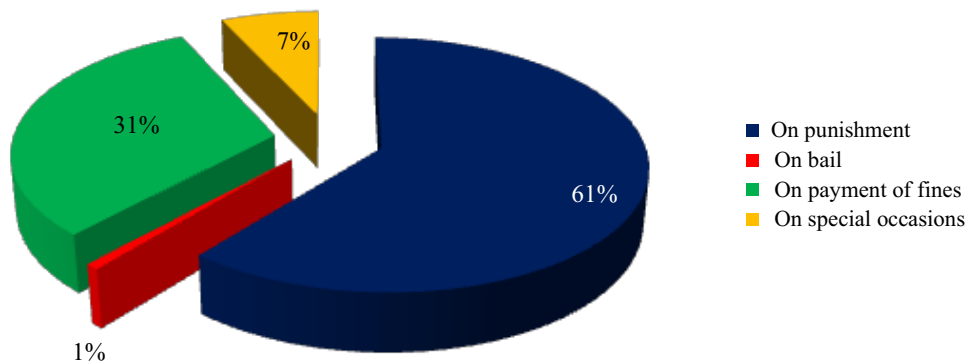

ESCAPES FOR 2013	-	232
RECAPTURED FOR 2013	-	95
NUMBER OF DEATHS FOR 2013	-	92

Source: Department of Prisons

INCREASE / DECREASE - 2013

	Year						Number			Percentage		
	2012			2013			Increase / Decrease			Increase / Decrease		
	Male	Female	Total	Male	Female	Total	Male	Female	Total	Male	Female	Total
Convicted prisoners	27,445	946	28,391	29,866	894	30,760	+2421	-52	+2369	+8.8	-5.5	+8.3
Condemned prisoners (Death Sentence)	122	9	131	120	4	124	-2	-5	-7	-1.6	-55.5	-5.3
Narcotic Drug offenders	9,130	151	9,281	10,238	210	10,448	+1108	+59	+1167	+12.1	+39	+12.6
Unconvicted prisoners	100,996	6,764	107,760	93,364	6,275	99,639	-7,632	-489	-8,121	-7.6	-7.2	-7.5
Youthful offenders	16	-	16	29	-	29	+13	-	+13	+81.2	-	+81.2

LENGTH OF SENTENCE - DIRECT ADMISSIONS OF CONVICTED PRISONERS - 2013

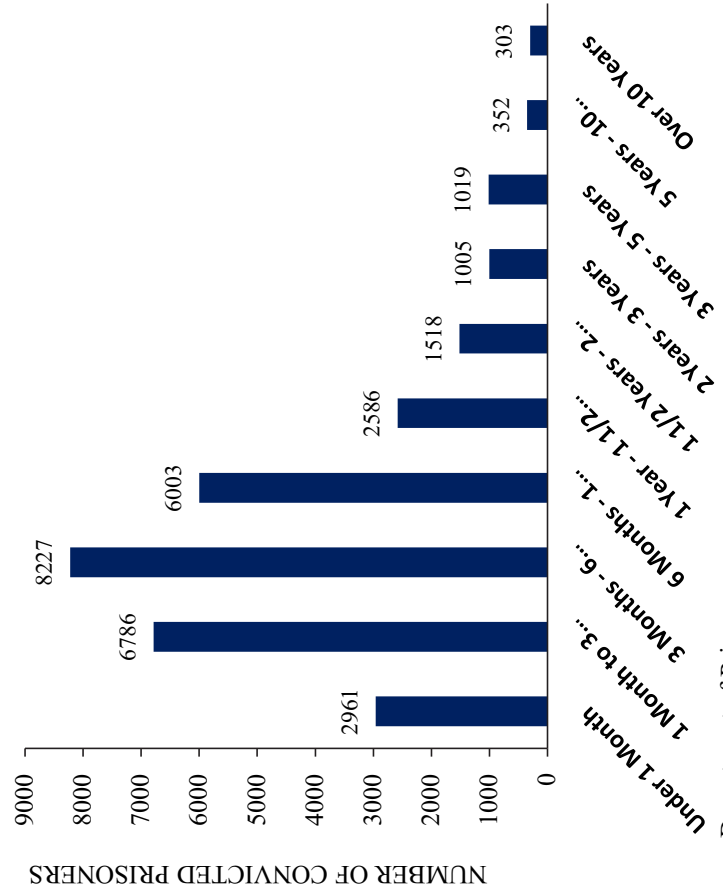

LENGTH OF PERIOD SPENT IN CUSTODY BY UNCONVICTED PRISONERS AS ON 31ST DECEMBER - 2013

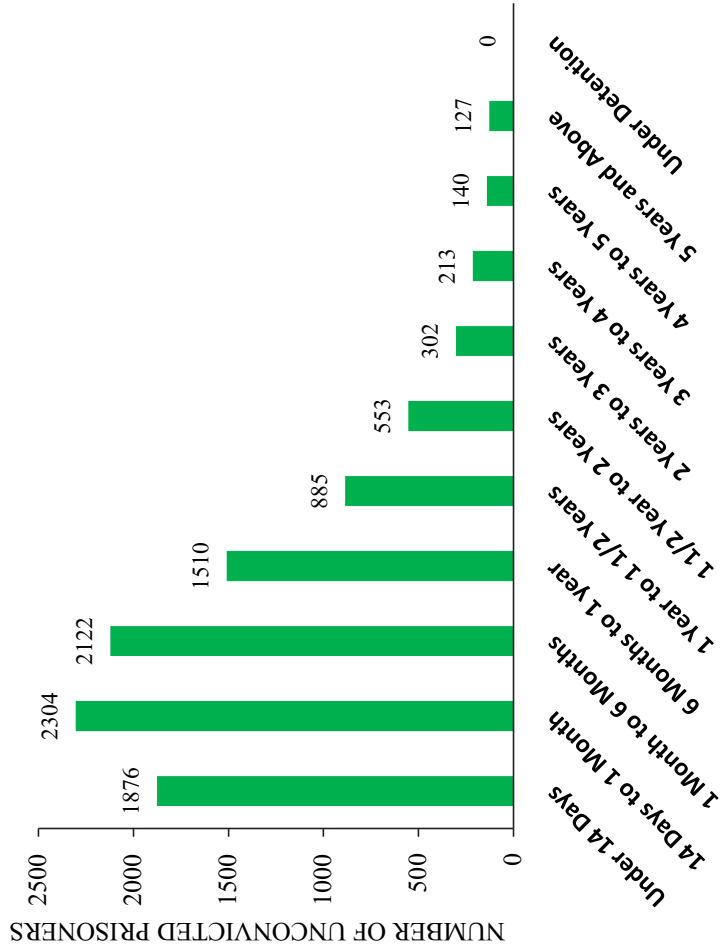

Source: Department of Prisons

